

LABORATORY EQUIPMENT

 **BOECO**
Germany

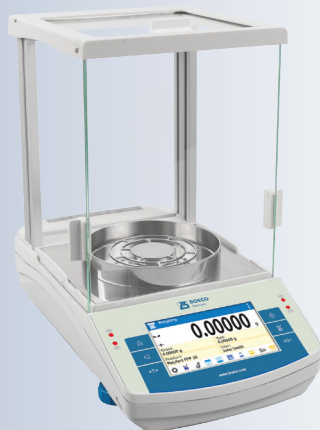

BALANCES



Model	Readability	Capacity
BXX 22	0,00001 g	82 g
(dual range)	0,0001 g	220 g

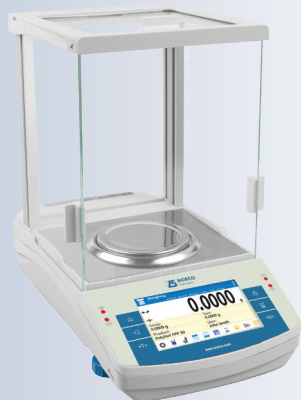

Model	Readability	Capacity
BXX 30	0,0001 g	310 g
BXX 31	0,0001 g	220 g

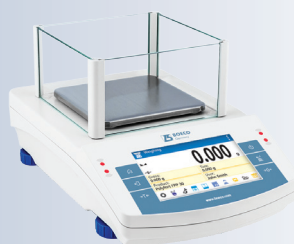

Model	Readability	Capacity
BXX 40	0,001 g	750 g



Model	Readability	Capacity
BXX 51	0,01 g	4500 g
Monoblock		

BOECO BXX MODELS

Our advanced level for Semi-Micro and Analytical balances with touch-screen and internal automatic calibration.

- » 5" colour capacitive touch-screen / maximum comfort of operation
- » Personal display design allows using a wide selection of widgets
- » Menu navigation selectable in many languages, interactive menu
- » Built-in IR sensors allow numerous operations (touch-free operations)
- » Conformity with GLP and GMP regulations
- » Dynamically controlled sample weight (bar graph)
- » Statistics, formulations, reports and printouts
- » Alibi memory with record of measurements
- » Complex databases
- » Kensington lock

» Functions: autotest, dosing, percent weighing, parts counting, peak hold, formulation, newton unit measurement, statistics, checkweighing, infrared sensors, under hook weighing, GLP procedures, animal weighing, air density correction, density determination, ambient conditions, replaceable unit, alibi memory, mass for titrator

Specification	BXX 22	BXX 30	BXX 31
Max. capacity	82 /220 g	310 g	220 g
Minimal load	0,001 g	0,01 g	0,01 g
Readability	0,00001/0,0001 g	0,0001 g	0,0001 g
Tare range	- 220 g	- 310 g	- 220 g
Repeatability	0,000015/0,0001 g	0,0001 g	0,0001 g
Linearity	± 0,0000/0,0002 g	± 0,0002 g	± 0,0002 g
Pan size	Open work pan ø 90 mm	ø 100 mm	ø 100 mm
Stabilization time	2 sec.	2,5 sec.	2 sec.
Calibration	Internal (automatic)		
Interface	2 x RS232, 2 x USB (A+B), WIFI, Ethernet		
Display	5" colour capacitive touch-screen		
Working temperature	+10°C - +40°C		
Power Supply	110-230 V AC, 50/60 Hz		
Netweight / Grossweight	7,3 kg / 8,8 kg		
Size / Packing size	333x206x355 / 495x400x515 mm		



Our advanced level touch-screen Precision balances with internal calibration.

Specification	BXX 40	BXX 51
Max. capacity	750 g	4500 g
Minimal load	0,02 g	0,5 g
Readability	0,001 g	0,01 g
Tare range	- 750 g	- 4500 g
Repeatability	0,015 g	0,01 g
Linearity	± 0,003 g	± 0,02 g
Pan size	128 x 128 mm	195 x 195 mm
Stabilization time	2 sec.	1,5 sec.
Calibration	Internal (automatic)	
Interface	2 x RS232, 2 x USB (A+B), WIFI	
Display	5" colour capacitive touch-screen	
Working temperature	+10°C - +40°C	
Power Supply	110-230 V AC, 50/60 Hz	
Netweight / Grossweight	3,9 / 7,2 kg	4,5 / 7,2 kg
Size / Packing size	333x206x100/170 / 530x440x410 mm	

BOECO BAS PLUS MODELS

Our Standard Analytical balance with automatic internal calibration

Display with enlarged characters, keypad with quick access buttons, communication interfaces 2 x USB (1 x to work with printers with PCL protocol) and optional WIFI

Kensington Lock, which allows to secure the device against theft.

» Functions: autotest, dosing, percent weighing, totalizing, parts counting, peak hold, Newton unit measurement, statistics, checkweighing, under hook weighing, GLP procedures, animal weighing, pipettes calibration, density determination.

Menu navigation selectable in many languages

Specification	BAS 31 plus
Max. capacity	220 g
Minimal load	0,01g
Readability (permissible)	0,0001 g
Tare range	- 220 g
Repeatability	0,0001 g
Linearity	± 0,0002 g
Pan size	∅ 100 mm
Stabilization time	2 sec.
Calibration	Internal (automatic)
Interface	2xRS232, 2xUSB(A+B), WIFI (optional)
Display	large LCD with backlight
Working temperature	+10°C - +40°C
Power Supply	110-230 V AC, 50/60 Hz
Netweight / Grossweight	7,3 kg / 10,7 kg
Size / Packing size	333 x 206 x 355 / 495 x 400 x 515 mm

The BAS 31 plus balance is available in an optional WIFI interface version

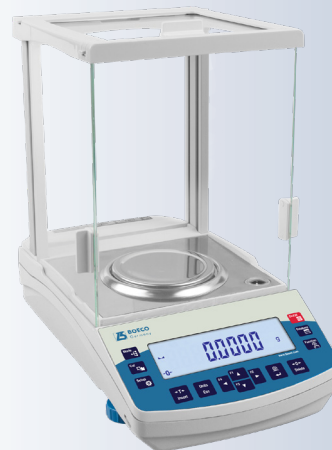

Model	Readability	Capacity
BAS 31 plus	0,0001 g	220 g

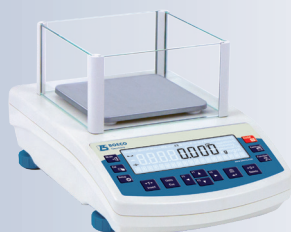

Model	Readability	Capacity
BPS 40 plus	0,001 g	750 g
BPS 41 plus	0,001 g	360 g



Model	Readability	Capacity
BPS 51 plus	0,01 g	4500 g
BPS 52 plus	0,01 g	2100 g

BOECO BPS PLUS MODELS

Our Standard Precision balances with automatic internal calibration

Display with enlarged characters, keypad with quick access buttons, communication interfaces 2 x USB (1 x to work with printers with PCL protocol) and optional WIFI.

» Functions: autotest, dosing, percent weighing, totalizing, parts counting, peak hold, Newton unit measurement, statistics, checkweighing, under hook weighing, GLP procedures, animal weighing, density determination

Menu navigation selectable in many languages

Specification	BPS 40 plus	BPS 41 plus	BPS 51 plus	BPS 52 plus
Max. capacity	750 g	360 g	4500 g	2100 g
Minimal load	0,02 g	0,02 g	0,5 g	0,5 g
Readability	0,001 g	0,001 g	0,01 g	0,01 g
Tare range	- 750 g	- 360 g	- 4500 g	- 2100 g
Repeatability	0,0015 g	0,001 g	0,01 g	0,01 g
Linearity	± 0,003 g	± 0,002 g	± 0,02 g	± 0,02 g
Pan size	128 x 128 mm		195 x 195 mm	
Stabilization time	2 sec.		1,5 sec.	
Calibration	Internal (automatic)			
Interface	2xRS232, 2xUSB (A+B), WIFI (optional)			
Display	large LCD with backlight			
Working temperature	+10°C - +40°C			
Power Supply	110-230 V AC, 50/60 Hz			
Netweight / Grossweight	3,9/7,1 kg	3,7/7,1 kg	4,5/7,1 kg	4,3/7,1 kg
Size / Packing size	333 x 206 x 100/170 / 530 x 440 x 420 mm			

All 4 BPSplus balances are available in an optional WIFI interface version

BOECO BWL MODELS

Our Basic Precision balances with external calibration and internal rechargeable accu with power charger. This makes them independent from a mains supply and therefore portable.

» Functions:

Parts counting, weighing in percent, totalising, checking, under hook weighing, animal weighing, GLP procedures, measurement in Newton.



Model	Readability	Capacity
BWL 51	0,01 g	2000 g
BWL 61	0,1 g	6000 g
BWL 60	0,1 g	10 kg

Specification	BWL 51	BWL 61	BWL 60
Max. capacity	2000 g	6000 g	10 kg
Readability	0,01 g	0,1 g	0,1 g
Tare range	- 2000 g	- 6000 g	- 10 kg
Repeatability	0,03 g	0,3 g	0,1 g
Linearity	± 0,03 g	± 0,3 g	± 0,1 g
Pan size	195 x 195 mm		
Stabilization time	3 sec.		
Calibration	external		
Interface	RS 232		
Display	LCD with backlight		
Working temperature	+15°C - +30°C		
IP rating	IP 43		
Power Supply	110-230 V AC, 50/60 Hz		
Operation time on batteries	45 hours (average time)		
Netweight / Grossweight	2,9 kg / 4,2 kg		
Size / Packing size	335x210x88 / 470x380x336 mm		



CALIBRATION WEIGHTS

cylindrical shape, nickel-plated and polished brass, packed in a lined plastic container, with DAkkS certificate

Code	Description
BOE F1-2000	Calibration weight, 2 kg, F1
BOE F1-5000	Calibration weight, 5 kg, F1
BOE F1-10000	Calibration weight, 10 kg, F1

BOECO BLC 600

Our low-cost balance. It is accurate, fast and versatile general purpose balance with weighing, counting, % weighing functions, weighing units conversion.

22 mm LCD with white LED back light display

All the keypads are light touch switches

The BLC 600 is supplied with a plastic windshield and a multiplug (EU/UK/US/AU) AC adaptor

Specification	BLC 600	BLC 6000
Max. capacity	600 g	6000 g
Readability	0,01/0,05 ct	0,1/0,5 ct
Linearity	± 0,02 g	± 0,2 g
Units	g/ct/lb/oz	g/ct/lb/oz
Calibration	Recommended adjustment weight 500 g	Recommended adjustment weight 5000 g
Tare range	Full capacity tare	Full capacity tare
Auto off	30 minutes off	30 minutes off
Operation	+10°C to +35°C / 50°F-95°F	+10°C to +35°C / 50°F-95°F
Power Source	5V/1A	5V/1A
Display	LCD 6 digits x 22 mm	LCD 6 digits x 22 mm
Dimension (LxWxH)	228 x 190 x 150 mm	228 x 190 x 80 mm
Pan size	Ø 120 mm	138 x 160 mm
Netweight	1020 g	1000 g

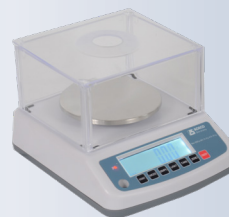

Model	Readability	Capacity
BLC 600	0,01 g	600 g
BLC 6000	0,1 g	6000 g

BOECO MOISTURE ANALYZER BMA H50, BMA I50

» Functions: drying modes, samples drying, water vapor permeability, halogen, humidity analysis, dry mass determination, elevated temperature level, GLP/GMP procedures.



Specification	BMA H50	BMA I50
Heating Module	Halogen emitter	Infrared emitter
Range of Drying temp	250°C	160°C
Max. capacity		50 g
Readability		0,001 g
Tare range		- 50 g
Max mass sampling		50 g
Accuracy of moisture reading		0,001 %
Repeatability		±0,05 % (sample < 2 g) ±0,01 % (sample >10 g)
Max. height of tested sample		h = 20 mm
Pan size		ø 90 mm, h = 8 mm
Drying modes	4 drying modes (standard, quick, step, mild)	
Auto switch off options	4 options (manual, automatic, time defined, user-defined)	
Additional functions	sample identification	
Power of heating device	400 W	
Interface	1xRS232, 2xUSB (A+B), WIFI (optional)	
Display	LCD with backlight	
Working temperature	+10°C - +40°C	
Power Supply	110-240 V AC, 50/60 Hz	
Netweight / Grossweight	4,8 kg / 6,2 kg	
Size / Packing size	333x206x190 / 470x380x336 mm	

BOECO MOISTURE ANALYZER BMX H50, BMX I50

as the above models BMA H50 and BMA I50 but with

- » LCD 5" capacitive colour touch-screen
- » The drying chamber can be opened and closed automatically using button or proximity sensors.
- » SMART DRY - prognosis of the Drying Process Result. It is an option dedicated for users who require fast and multiple estimation of the materials moisture content. SMART DRY method is a prognosis of the end result carried out before the drying process is completed.



Specification	BMX H50	BMX I50
Heating Module	Halogen emitter	Infrared emitter
Range of Drying temp	250°C	160°C
Max. capacity		50 g
Readability		0,001 g
Tare range		- 50 g
Max mass sampling		50 g
Accuracy of moisture reading		0,001 %
Repeatability		±0,05 % (sample 2 g) ±0,01 % (sample 10 g)
Max. height of tested sample		h = 20 mm
Pan size		ø 90 mm, h = 8 mm
Drying modes	4 drying modes (standard, quick, step, mild)	
Auto switch off options	4 options (manual, automatic, time defined, and user-defined)	
Additional functions	sample identification	
Power of heating device	400 W	
Interface	1xRS232, 2xUSB (A+B), WIFI	
Proximity sensors	2	
Display	LCD 5" capacitive colour touch-screen	
Working temperature	+10°C - +40°C	
Power Supply	110-240 V AC, 50/60 Hz	
Netweight / Grossweight	5,2 kgs / 6,7 kgs	
Size / Packing size	333x206x190 / 595x395x420 mm	

ACCESSORIES FOR BMA/BMX MOISTURE ANALYZERS

Code	Description
BOE PAN90	Aluminium sample pans, round, $\varnothing = 90$ mm (box of 50)
BOE 440017	Glass fiber filters MG 161, 90 mm \varnothing , with binder, anorganic, 75 g/m ² (box of 50)
BOE F1-50	Calibration weight, 50 g, F1, cylindrical shape nickel-plated and polished brass, packed in a lined plastic container, with DAkkS certificate

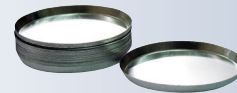

ACCESSORIES

Code	Description
BOE KIT 85	Density determination KIT for solids and liquids, for balances featuring weighing pan \varnothing 85, 90 and 100 mm
BOE KIT 128	Density determination KIT for balances with weighing pan 128 x 128 mm
BOE KIT 195	Density determination KIT for balances with weighing pan 195 x 195 mm
BOE P0108	RS 232 cable (balance-computer)
BOE USBAB	USB cable Typ A to B (balance-computer)
BOE DC-1	Dust cover for BAS / BXX Plus analytical balances
BOE DC-2	Dust cover for BPS 51 PLUS / BPS 52 PLUS, BXX 51 and BWL 51 / BWL 60 / BWL 61 balances

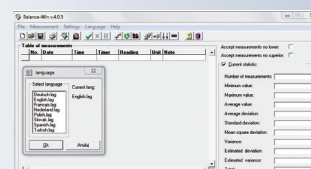

SPECTROPHOTOMETERS

BOECO SPECTROPHOTOMETER MODELS S-200 VIS & S-220 UV/VIS

The BOECO S-220 (UV/VIS) and S-200 (VIS) are high quality, compact, low cost measurement systems for daily analysis in education, QC and basic research.

» Compact single beam optics with full range scanning

The single beam optics are compact and bench space saving. The long life Hamamatsu Xenon lamp optics in the S-220 ensure quick and reliable performance and the Tungsten Halogen lamp used in S-200 also provide a reliable measurement.

» Color touch screen operation

The intuitive color touch screen operation provides simple access to an extensive range of functions. The touch screen is sensitive to stylus and laboratory gloves. Icon driven on-board software improves accessibility and the graphical display allows spectrum or standard curve to be shown on the screen. The forward and back quick key allows the user to proceed or swiftly return to the process. An enlarged data display for photometry measurement makes result reading easier.

» Various measurement modes

Operation modes include photometric, multiple wavelength analysis, spectrum scanning, time scan and kinetics; direct concentration results are included.

» Optional accessories

A variety of accessories are included such as test tube holder, flow cell with sipper, temperature control holder, long path length cuvette holder & multiple cell holder are available to enhance different application needs.

» Storage and data output

External storage with SD card and free downloadable PC Software MasterReport (www.boeco.com) allows data export to PC in compatible text or spreadsheet format for further data processing in the PC. Method and result storage is almost unlimited by exchanging SD card when needed. Printer options are available for direct result printing with graphics.

» Validation function

To ensure optimum instrument performance, self diagnosis functions are equipped in GLP/GMP feature for performance validation and auditing.



S-200
S-220

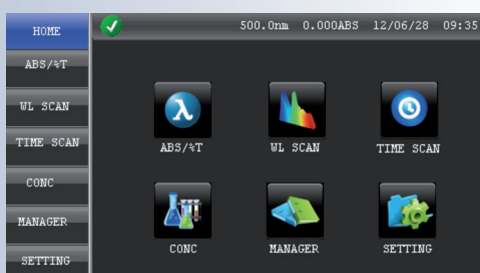

MAIN MENU

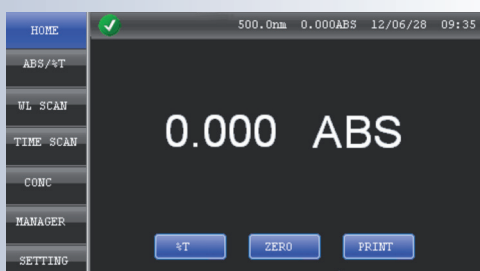

LARGE DISPLAY MEASURE

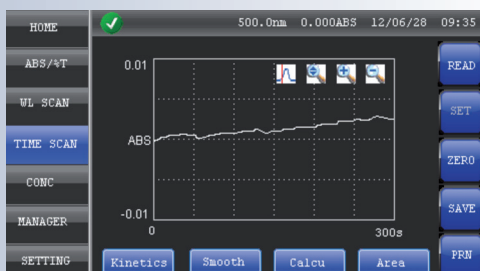

TIME SCAN RESULTS AND DATA
PROCESSING

Code	Description
BOE 8620000	Model S-200 Vis Spectrophotometer, single beam with full range scanning and color touch screen operation. Supplied with 10 x 10 mm cuvette holder
BOE 8622000	Model S-220 UV/Vis Spectrophotometer, single beam with full range scanning and color touch screen operation. Supplied with 10 x 10 mm cuvette holder

Specification

S-200 Vis

S-220 UV/Vis

Wavelength Range:	320 to 1100nm	190 to 1000nm
Spectral Bandwidth:	6nm	5nm
Transmittance accuracy:	±0,5% T (NIST 930 Filter)	±1% T (NIST 930 Filter)
Transmittance repeatability:	0.2% T	0.5% T
Baseline flatness:	± 0.002 Abs (330-1090nm)	± 0.005 Abs (200-990nm)
Noise level:	≤ 0.001 Abs (500nm)	≤ 0.005 Abs (250 nm)
Baseline stability:	≤ 0.001 Abs/h (500nm) (after 2 hours warm up)	≤ 0.005 Abs/h (250nm) (after 2 hours warm up)
Stray light:	≤ 0.5% T	≤ 0.5% T
Wavelength controlled variable:	0.2nm	0,2nm
Wavelength accuracy:	± 1nm	± 2nm
Wavelength repeatability:	≤ 0,5nm	≤ 1nm
Wavelength scan speed:	2400nm/min (0,2 sampling interval without filter)	300nm/min (0,2 sampling interval without filter)
Wavelength move speed:	to any specified position within 1sec.	to any specified position within 1sec.
Absorbance:	-0.3 to 1.999	-0.3 to 1.999
Transmittance:	0 to 199.9%	0 to 199.9%
Spectrum Scanning:	Yes	Yes
Concentration:	-300 to 1999	-300 to 1999
Selectable Resolution:	1, 0.1, 0.01 or 0.001	1, 0.1, 0.01 or 0.001
Light source:	Tungsten Halogen lamp	pulsed-Xenon lamp
Detector:		Silicon photodiode
Display screen:		4,3 inches colorful touch LCD screen
Printer:		specified 80-column thermal printer (series port)
Metering mode:		Single beam
Memory:		SD card storage
Time Scan:		Graphical and calculated concentration value
Analysis:		Absorbance and wavelength of peaks and valleys
GLP:		Real time clock and calendar, Self Diagnosis
Size:		400 (W) x 280 (D) x 160 (H) mm
Power requirement:		AC, 100-240V, 50/60Hz
Power consumption:		100VA
Communication ports:		Serial printer port connects thermal printer USB port connects PC
		SD card port saves data and measurement methods
		Accessories port connects and controls serval options
Weight:		4,7 kg

Accessories

Code	Description
BOE 8620005	Test tube holder (only for S-200)
BOE 8622004	Rectangular long-path cuvette holder for cuvettes with 10, 20, 30, 50 and 100 mm path-length
BOE 8620003	Micro-cuvette holder, for cuvettes with centre height of 15 mm
BOE 8620020	Flow cuvette holder, incl. quartz glass flow cuvette of 150 µl
BOE 8620030	Set of Auto sample sipper and Flow cuvette holder with quartz glass flow cuvette of 150 µl
BOE 8622040	Electronic thermostat (Peltier element) TC cuvette holder (only for S-220, S-300)
BOE 8620050	Automatic 5 position cuvette holder
BOE 8620060	Thermo printer with 100V-240V AC power supply
BOE 8620001	Tungsten halogen lamp (S-200)
BOE 8622001	Xenon Lamp module (S-220, S-300)

BOE 8622070 UV DETECTIVE software to control and operate the spectrophotometer on a PC. The versatile software can control all spectrophotometer operations such as photometry, wavelength scans, time scans and more.

Further functions include storage of methods programs, saving of numerical and graphical data, downstream data processing, data transfer to commercial spreadsheets such as Excel® and report generation.

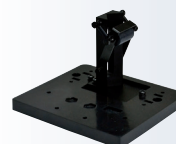

TEST TUBE HOLDER

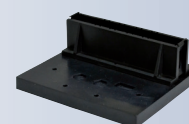

LONG PATH CUVETTE HOLDER

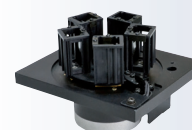

5-PLACE AUTO SAMPLE HOLDER



ELECTRONIC THERMOSTAT HOLDER

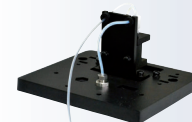

FLOW CUVETTE HOLDER



SAMPLE SIPPER



THERMO PRINTER

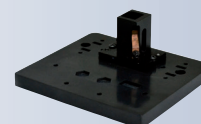

MICRO CUVETTE HOLDER

BOECO LIFE SCIENCE SPECTROPHOTOMETER MODEL S-300

The BOECO S-300 life science spectrophotometer allows measurement of nucleic acid concentrations and purity (using ratio function) including protein concentrations. As a high quality spectrophotometer, the S-300 features touch screen operation packaged as a lightweight system with a compact footprint for life science and education related applications.



S-300

» Life Science Programs

The S-300 contains onboard functions for the quantification of nucleic acid, including dsDNA, ssDNA, RNA and Oligonucleotides. The purity of the nucleic acid can also be determined with the ratio A260/A280 calculation. Protein concentrations can be measured from a range of colourimetric assays such as Bradford, Lowry, Biuret and BCA. Standard calibration data and curves can also be displayed. Furthermore, proteins can be quantified at 280nm. Bacterial cell density at 600nm can also be measured under the OD600 cell culture optical density function. It can define a bacterial culture in exponential growth phase and at the most appropriate time for harvest or induction.

» Compact Optics with Full Range Scanning

The single beam optics are compact resulting in significant bench space saving. The long life Hamamatsu Xenon lamp optics system in the S-300 ensures quick and reliable performance.

» Color Touch Screen Operation

The intuitive color touch screen provides simple access to an extensive range of function. The touch screen is sensitive to stylus or hands (with and without gloves). Icon driven on board software improves accessibility and the quick action keys are another convenience feature.

» Various measurement modes

In addition to the Lifescience program, the S-300 also features conventional spectrophotometer functions such as single/ multiple wavelength analysis, spectrum scanning, kinetics and concentration measurement.

» Optional accessories

A various selection of optional accessories is available such as flow cell with sipper, temperature control holder, long path length cuvette holder & multiple cell holder to enhance different application needs.

» Storage and data output

External storage with SD card allows data export to PC in compatible text or spreadsheet format. Free downloadable PC Software MasterReport (www.boeco.com) allows data export to PC in compatible text or spreadsheet format for further data processing in the PC.

Method and result storage is almost unlimited by exchanging SD card when needed. Printer options are available for direct result printing with graphics.

» Validation function

To ensure optimum instrument performance, self diagnosis functions are equipped in GLP/GMP feature for performance validation and auditing.

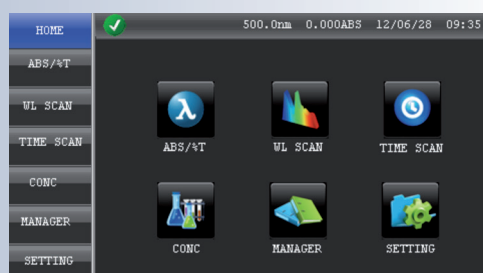

MAIN MENU

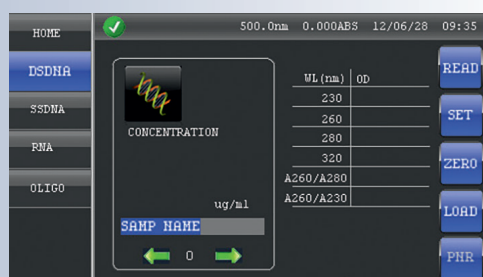

Code	Description
BOE 8630000	Model S-300 UV/Vis Life Science Spectrophotometer, single beam with full range scanning and color touch screen operation. Supplied with installed micro cuvette holder (centre height 15 mm) and with optional 10 x 10 mm cuvette holder and sample pack of 8 pcs. disposable UV Micro Cuvettes

Specification

Wavelength Range:	190 to 1000nm
Wavelength Resolution	0.2nm
Spectral Bandwidth:	5nm
Transmittance accuracy:	±1% T (NIST 930 Filter)
Transmittance repeatability:	0.50% T
Detection limit Concentration:	dsDNA 1.5 - 100µh/ml (for 100µl cell)
Noise level:	0.005 Abs (at 250 nm)
Stray light:	≤ 0.5% T at 220, 340 nm
Wavelength accuracy:	± 2nm
Wavelength repeatability:	≤ 1nm
Absorbance:	-0.3 to 1.999
Transmittance:	0 to 199.9%
Spectrum Scanning:	Yes
Concentration:	0 to 1999
Light source:	pulsed-Xenon lamp
Detector:	Silicon photodiode
Display screen:	4,3 inches colorful touch LCD screen
Printer:	specified 80-column thermal printer (series port)
Metering mode:	Single beam
Memory:	SD card storage
Time Scan:	Graphical and calculated reaction activity
Wavelegth Scan Analysis:	Absorbance and wavelength of peaks and valleys
GLP:	Real time clock and calendar, Self Diagnosis
Size:	400 (W) x 280 (D) x160 (H) mm
Power requirement:	AC, 100-240V, 50/60Hz
Power consumption:	100VA
Communication ports:	Serial printer port connects thermal printer USB port connects PC SD card port saves data and measurement methods Accessories port connects and controls serval options
Weight:	4,7 kg

BOECO MICRO UV-VIS SPECTROPHOTOMETER MODELS N-1 TOUCH & N-1C TOUCH

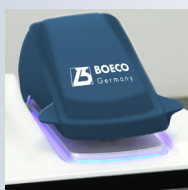
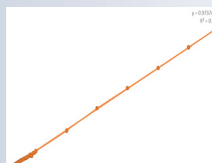
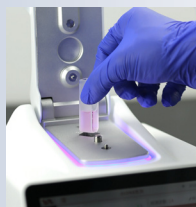
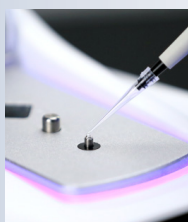
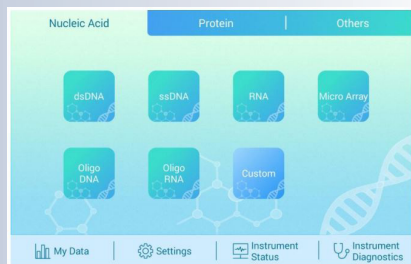

The BOECO N-1 / N-1C Touch Micro volume (UV-Vis) spectrophotometers with built-in 7-inch color touch screen, can complete all detection functions without connecting a computer, display test results in real time, store historical data, and export to a computer. The Android operating system, optimized for the touch operation habits, improves the operating feelings. The integrated design and compact size are ideal to save the space in the crowded laboratories, or as the in-vehicle mobile inspection device. It can be applied to the concentration detection of nucleic acids, proteins, bacterial cell cultures, etc., as well as the absorbance measurement of unknown samples.

The variable path length of the N-1C Touch Micro UV-Vis Spectrophotometer realizes both the minimum sample volume pedestal detection as low as 0.5 μ L, suitable for precious samples, and the detection to the high concentration samples without dilution at all. Including the liquid drop, it builds in the standard cuvette detection module for more use.

Features

Large size colour touch screen

Built-in-7-inch high resolution color touch screen for more detection information, all operations can be done on the screen.

Two models in one (N-1C Touch)

Pedestal Micro volume or cuvette mode, to meet the flexible detection need. The cuvette module has a heating stirrer.

Wide detection range

The 0.03 minimum detection path length, combined with a new generation spectrophotometer, increases the maximum detection concentration to 27,500 ng/ μ l and the lowest detection concentration as low as 0,2 ng/ μ l

Stability for long life

Long-life xenon flash lamp of Hamamastu ensures stability of detection and the long life of the instrument.

The lifting detection base with sliding bearing structure has high precision, not easy to damage.

Ultra-wide wavelength range

With continuous wavelength range as 185-910nm, the instrument can detect various samples through selecting any band. It adapts to a variety of detection requirements with wide range of near infrared wavelength.

Accurate path length

The stepper motor combined unique double track technology (DPTL), allows the precision of optical path length as 0.001mm, thus to achieve highly repeatability of absorbance detection.

Cuvette detection mode (N-1C Touch)

The cuvette detection mode comes with magnetic stirring function. User can set the heating function and stirring speed for dynamic analysis detection.

And the user can define different path length, such as 1mm, 2mm, 5mm, 10mm.

Android operating system

The spectrophotometer has a built-in operating system and detection software, without need of a computer. Graphical touch operation is in line with user friendly design and improves work efficiency.

Light status

The lighting strip around the test stand flashes with different states to show the detection process straightforwardly

Multi-functions

Nucleic acid detection

Built-in common calculation formula of dsDNA, ssDNA, RNA, Oligo-DNA, Oligo-RNA, can get the concentration and purity of samples automatically.



NUCLEIC ACID DETECTION

UV visible custom scanning

In the full wavelength range, set the detected wavelength through increasing or decreasing wavelength with 1 nm as expected.

Nucleic acid fluorescence marker detection

Preinstall extinction factor of commonly used fluorescent dyes of dsDNA, ssDNA, RNA, Oligo-DNA, Oligo-RNA.

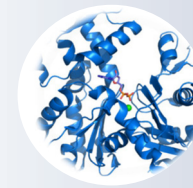

PROTEIN DETECTION

Protein detection

Can detect the concentration of protein solution, or detect protein concentration of dye marker. Built-in common detection methods of BCA, Bradford, Lowry, Pierce 660nm.

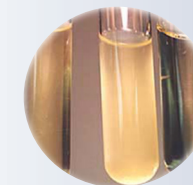

CELL DETECTION

Cell detection

Can detect absorbance value at 600nm automatically. Meanwhile, it can detect absorbance value at any band under set wavelength range.

Code	Description
BOE 8638000	Model N-1 Touch micro UV/Vis Spectrophotometer, with pedestal microvolume mode
BOE 8638100	Model N-1C Touch micro UV/Vis Spectrophotometer, with pedestal microvolume and cuvette mode

Research use only

Specification	N-1C touch	N-1 touch	
Parameters			
Detector		2048-element liner CCD array	
Light Source		Xenon flash lamp	
Mini.Sample Amount (µl)		0.5	
Pathlength (mm)		0.03, 0.05, 0.1, 0.2, 1.0 auto ranging	
Wavelength Range (nm)		185-910	
Wavelength Accuracy (nm)		±1	
Spectral Resolution (nm)		≤1.8(FWHMat Hg 253.7nm)	
Photometric Accuracy		0-550 (10 mm equivalent)	
Measurement Repeatability		0.002 (1mm optical length)	
Limit of Detection		Pedestal: 2ng/µl ds DNA, 0,006 mg/ml BSA, 0,03 ng/ml IgG	
Maximum Concentration		Pedestal: 27.500 ng/µl ds DNA, 820ml/ml BSA, 400 mg/ml Lg	
Limit of Detection		2ng/µl dsDNA	
Measurement Time		5 Sec.	
Cuvette Mode	Heating Temp.(°C)	37±0.5	NA
	Cuvette Stirring Speed (RPM)	150-900 / 10 Speeds	NA
	Cuvette photometric	0-1,5A (10 mm)	NA
	Cuvette Limit of Detection	0.2ng/µl dsDNA, 0,006mg/ml BSA, 0,003 mg/ml LgG	NA
Display		7 inch, 1280 x 800 high definition LCD	
Internal storage		32GB flash memory	
PC software requirements		Windows 7:32/64 bit, Windows 8/10 64 bit	
Data transfer & PC connecting		USB, Wifi	
Power		AC 110 V - 220 V, 50/60 Hz (Power adapter)	
Net Weight		2,3 kg	

CUVETTES

Disposable Cuvettes:

Code	Description
BRA 759007	Disposable Macro Cuvettes, PS, Window: 10 x 35 mm; 10 mm light path Filling volume: min 2,5 / max 4,5 ml grouped by mold cavity number, neutral packing Wavelength: From 340 to 900 nm Packing: 100 pcs./box, 1000 pcs./carton
BRA 759017	Disposable Semi-Micro Cuvettes, PS, Window: 4,5 x 23 mm; 10 mm light path Filling volume: min 1,5 / max 3,0 ml grouped by mold cavity number, neutral packing Wavelength: From 340 to 900 nm Packing: 100 pcs./box, 1000 pcs./carton
BRA 759170	BRAND Disposable UV Macro Cuvettes, Filling volume: min 2,5 / max 4,5 ml grouped by mold cavity number, Wavelength: From 220 to 900 nm, 10 mm light path, pack of 100 pcs.
BRA 759150	BRAND Disposable UV Semi-Micro Cuvettes, Filling volume: min 1,5 / max 3,0 ml grouped by mold cavity number, Wavelength: From 220 to 900 nm, 10 mm light path, pack of 100 pcs.
BRA 759220	BRAND Disposable UV Micro Cuvettes, Center height 15 mm, Vol. 70 µl up to 550 µl, Wavelength: From 220 to 900 nm, 10 mm light path, pack of 100 pcs.

Optical and quartz glass Cuvettes:

Code	Description
BOE 104010	BOECO economic Macro cell, Optical glass, 340-2500 nm 10 mm lighth path, PTFE lid, Volume 3,5 ml 2 pcs. / pack
BOE 204010	BOECO economic Macro cell, Quartz glass, 190-2500 nm 10 mm lighth path, PTFE lid, Volume 3,5 ml 2 pcs. / pack
HEL 6030-10-10	HELLMA Macro Cuvette 6030-OG without lid, Optical glass, 360-2500 nm. 10 mm light path
HEL 6030-UV-10-531	HELLMA Macro Cuvette 6030-UV without lid, Quartz glass, 260-2500 nm, 10 mm light path
HEL 6040-10-10	HELLMA Semi-Micro Cuvette 6040-OG without lid, Optical glass, 360-2500 nm, 10 mm light path
HEL 6040-UV-10-531	HELLMA Semi-Micro Cuvette 6040-UV without lid, Quartz glass, 260-2500 nm, 10 mm light path
HEL 100-10-20	HELLMA Macro Cuvette 100-OS with PTFE lid, Optical glass, 320-2500 nm, 10 mm light path
HEL 100-20-20	100-OS with 20 mm light path
HEL 100-50-20	100-OS with 50 mm light path
HEL 100-100-20	100-OS with 100 mm light path
HEL 100-10-40	HELLMA Macro Cuvette 100-QS with PTFE lid, Quartz glass, 200-2500 nm, 10 mm light path Volume 3,5 ml
HEL 100-20-40	100-QS with 20 mm light path
HEL 100-50-40	100-QS with 50 mm light path
HEL 100-100-40	100-QS with 100 mm light path
HEL 105-202-15-40	HELLMA Ultra-Micro Cuvette 105.202-QS with PE stopper, Quartz glass, 200-2500 nm 10 mm light path, Centre height 15 mm Chamber volume 50 µl, Filling volume 70 µl



MACRO



SEMI-MICRO



MICRO



BOE 104010



HEL 6030-OG



HEL 6030-UV



HEL 6040-OG



HEL 6040-UV



HEL 100-OS/10



HEL 100-OS/100



HEL 105.202-QS

BOECO CLINICAL PHOTOMETER MODEL PM-51

- » Semi-automated photometric system
- » Effective temperature regulation system
- » Flexible cuvette concept, interchangeable flow-through or standard cuvette
- » Reagent-open system with high capacity for programmable methods
- » Teach-in capability for reagent application via touchscreen
- » Minimum sipping volume 250 µl
- » Double-secured liquid control with infrared bubble detector
- » Future-proof operation, can easily be upgraded



Specification:

Type:	Semi-automatic, single-beam filter photometer
Light Source:	Halogen lamp - 12 V, 20 W with protection for lifetime
Wavelength:	340 nm - 800 nm
Wavelength Selection:	Automatic via 9-position filter wheel: 6 standard interference filters: 340 nm, 405 nm, 492 nm, 546 nm, 578 nm, 623 nm, 3 positions for optional filter of choice
Photometric Range:	0 - 2.5 Bel
Cuvette System:	Microflow cell: 32 µl, 10 mm light path interchangeable with normal standard cuvettes (macro or semi-micro, disposable or special optical glass) Temperature Control Internal Peltier element, temperature variable, pre-adjusted to 25 °C, 30 °C and 37 °C Equilibration time for aspirated reaction mixture to reach 37 °C from ambient temperature: 15 sec
Aspiration System:	Built-in peristaltic pump driven by stepper motor programmable aspiration volume controlled by infrared light barrier
Sipping Volume:	Minimum 250 µl, typically 500 µl up to 2000 µl Separate setting of aspirate volume and wash volume
Operator interface:	Touchscreen, for direct functions and alphanumeric inputs
Data Presentation:	Graphic display, White characters or symbols, blue background, lighted, resolution 240 x 126 dots.
Integrated Printer:	Thermal printer, 24 characters per line
Languages:	English, German, Spanish, French, Russian and Indonesian
Memory:	General operating software can be updated by PC Reagent open system with capacity for up to 231 programmable methods Import of data by touchscreen or PC Up to 50 non-linear calibration curves with max. 20 sets of points can be stored
Data Logging:	Up to 1000 results can be saved in memory automatically
Signal Port:	1 serial port for connection to an external printer or PC (bidirectional interface)
Measurement Procedures:	» Absorbance » Endpoint with standard, factor or multiple standards, with or without reagent blank and/or sample blank » Bichromatic end point » Kinetics with standard, factor or multiple standards, with or without blank » Fixed time with standard, factor or multiple standards, with or without reagent blank » Turbidimetry with optional timer function » Single, double and triple determinations » Curve fitting for non-linear standard curves » Free hemoglobin in combination with optional interference filters
Measuring Time:	» Kinetic: variable from 3 - 19 deltas, time per delta 4 - 255 sec. » Fixed time: variable from 0 - 65535 sec.
Delay Time:	Programmable from 0 - 65535 sec.
Mains Supply:	Range 100 VAC up to 240 VAC at 50/60 Hz
Dimensions:	Length 33 cm x Width 34 cm x Height 18 cm
Weight:	5,3 kg

Code

BOE PM-51

Description

BOECO photometer PM-51, with integrated printer, flow-through cell, standard cuvette adapter and filter wheel (340-405-492-546-578-623 nm), 90-264 V, 50/60 Hz

BOECO BMR-100 MICROPLATE READER

Our BMR-100 Microplate Reader is a reliable and robust instrument for a wide variety of research and clinical applications. It reads various kinds of 96-well plates and is equipped with shaking function. It can be used as a stand alone instrument or under PC control with a regular or APP software

- » Easy to use with a 7 inch touch screen together with 3 external keys
- » A broad wavelength range of 340-750nm
- » Able to use as a stand alone or with PC control software to export the results
- » Absorbance range: 0.0~4.000Abs
- » 8 position optical filter wheel equipped with 4 standard optical filters
- » Fast and accurate measurement of 96-well plates within 6 seconds

Safety

The drawer is controlled by a motor, if there is anything blocked when it is closing, the motor would draw back to protect the user. The light source and optical filters can be exchanged without opening the cover

Software

BMR-100 keeps with high visual and logical user interface of software. It offers a comprehensive inbuilt calculation, such as blank subtraction, quantitative curve fit, qualitative classification and kinetic calculations, as well as the versatile reporting tool and further provides data reduction

Specification

Display:	7 inch touch screen (800x480 dots)
Light source:	Quartz-halogen lamp 6V/10W
Wavelength:	340-750 nm
Optical filter:	Standard filters 405, 450, 492, 630 nm
Half-bandwidth of filters:	3~9 nm
Read-out range:	0~4.000 Abs
Linearity (405 nm):	0~2.000 Abs $\leq \pm 1\%$, 2~4.000 Abs $\leq \pm 2\%$
Resolution:	0.001 Abs 1
Accuracy (405 nm):	$\pm 1\%$ (0-3Abs), $\pm 2\%$ (3-4Abs)
Precision (405 nm) :	CV $\leq 0.2\%$ (0-3Abs), CV $\leq 1.0\%$ (3-4 Abs)
Test speed	<6s for 96 well plate
Incubator:	No
Shaking:	3 modes of shaking: slow, medium and fast
User interface:	Integrated software or PC control software
Operation:	Touch screen, 3 pcs external keys
Storage:	200 programs and 100.000 test records
Ports:	3 USB ports, for PC, printer and USB-disk
Dimensions (W x D x H)	440 x 295 x 225 mm
Weight:	10 kg

Code	Description
BOE 8160500	BMR-100 Microplate Reader with standard filters 405, 450, 492, 630 nm, 100-240 V, 50/60 Hz

Optional Filters

BOE 8160511	Optical filter 340 nm
BOE 8160512	Optical filter 380 nm
BOE 8160513	Optical filter 415 nm
BOE 8160516	Optical filter 540 nm
BOE 8160518	Optical filter 570 nm
BOE 8160519	Optical filter 578 nm
BOE 8160521	Optical filter 595 nm
BOE 8160523	Optical filter 650 nm
BOE 8160514	Optical filter 690 nm



BOECO IW-8 INTELISPEED MICROPLATE WASHER

The Intelispeed Washer IW-8 is designed for washing of standard flat-bottom 96 well plates and microstrips. The unit is fully programmable ensuring multi-step solution ripening, aspiration (aspiration, combination of aspiration/liquid dispensing and soaking, as well as soaking cycle during a particular period of time).

The unit has 100 user-defined programs. Standard version is supplied with 8-channel washing head for dispensing/aspiration, 3 bottles for washing and rinsing solutions, a waste bottle and bottle with filter. Optional 4-channel washing solution weight logger 4 CHW Logger is available.

The unit is designed for washing standard 96-well plates during analyses.

The unit provides:

- » Washing mode
- » Rinsing mode
- » Mixing mode
- » Double aspiration
- » Possibility of additional solution mixing during time gap between two work cycles
- » Possibility to use microtest plates by different manufacturers, ensured by automated plate set up (adjusting to different depths of plate wells)
- » Plate and strip washing mode
- » User-defined programs with adjustable parameters
- » Saving work programs

The unit is designed for use in closed laboratory rooms at temperatures from +10 to +35°C and relative humidity up to 80% at +25°C decreasing linearly to 50% relative humidity at 35°C

4-channel washing solution weight logger 4 CHW Logger provides automatic control of rinsing solution and waste volumes. The washer shows remaining volume for each bottle as percentage and gives a warning message in case of low solution volume or full waste bottle when 4 CHW Logger is connected.



Specification

Detection mode:	Absorbance
Minimum dispense volume:	25 µl
Maximum dispense volume:	1600 µl
Dispense increment:	25 µl
Dispensing accuracy:	±2.5%
Allowed residual liquid volume in plate well:	not more than 2 µl
Number of wells washed simultaneously:	8
Number of washing cycles for each channel:	1–15
Aspiration time:	0.2–3 s
Aspiration/dispensing speed:	3 levels
Max. number of channels in a program:	2
Soaking time:	0–300 s (increment 10 s)
Shaking time:	0–150 s (increment 5 s)
Number of washed rows:	1 – 12
Time of plate single wash (350 µl), no more:	45 s
Number of programs:	100
Plate platform and washing head movement:	automated
Indication of operation modes:	8-line LCD
Dimensions:	375 x 345 x 180 mm
Weight with accessories:	9,6 kg
External power supply:	DC 12 V, 5 A
Consumed power, not more:	60 W

4 CHW Logger Specifications

Max. loading per scale cup:	2 kg
Overall dimensions:	267 x 252 x 97 mm
Weight:	3 kg

Code	Description
BOE 8078000	IW-8 Intelispeed Microplate Washer, 100-240 V, 50/60 Hz incl. bottles & external power supply unit
BOE 8078010	4 CHW logger

MILK ANALYZER



BOECO LAC-SP
BOECO LAC-SPA



BACKPANEL

BOECO MILK ANALYZER LAC-SP, LAC-SPA

The function of the BOECO Ultrasonic Milk Analyzer is to make quick analyses of milk samples directly after milking, at collecting and during processing.

The BOECO Milk analyzer makes quick analyses of milk and liquid dairy products as: Cow milk, UHT milk, Sheep milk, Goat milk, Buffalo milk, Camel milk, Whey, Cream (up to 45%), Skimmed milk (0,01% FAT, Ice-cream mixtures, Concentrated milk (up to 1160 kg/m³), Yogurt, Flavoured milk, Recovered milk.

Each unit will be delivered with 3 calibrations (standard are sheep, cow and UHT milk)

The model LAC-SP has one peristaltic pump for the sample aspiration. The model LAC-SPA has two pumps. The second one for automatic cleaning

The key features are:

- » User-friendly: simple in operation, maintenance, calibration and installation
- » Portable and compact design
- » Very small quantity of milk required (25 ml per one measurement)
- » Low power consumption
- » No use of hazardous chemicals
- » Measuring accuracy adjustment can be done by the user RS 232 interface
- » ESC POS Printer Support
- » Two samples self-calibration
- » Dimensions 175x175x150 mm (WxDxH)
- » Weight: < 1,5 kg
- » Power: Input 100-240V ~1,6 A max, 50/60 Hz, Output +12V 4.17 A min

The following Parameters can be measured from the Ultrasonic system:
Fat, Solid-non-fat (SNF), Density, Protein, Lactose,
Milk sample temperature, Added water, Salts, Freezing point.

The following Parameters can be measured from integrated systems:
pH (together with an electrode), Conductivity, Inhibitors

Parameter	Measuring range	Accuracy
Fat	from 0,01% to 25% (option 45%)	± 0.1%
SNF (Solids-non-fat)	from 3% to 15%	± 0.15%
Density	from 1015 to 1140 kg/m ³ (option 1160 kg/m ³)	± 0.3 kg/m ³
Protein	from 2% to 7%	± 0,15%
Lactose	from 0.01% to 6%	± 0.15
Added Water content	from 0% to 70%	± 3.0%
Temperature of milk	from 1°C to 40°C	± 1°C
Freezing point	from -0,4 to -0,7°C	± 0.001°C
Salts	from 0,4 to 1,5%	± 0.05%
pH	from 0 to 12	± 0,05%
Total solids	from 0 to 50 %	± 0,17%
Option		
Conductivity	from 3 to 14 (mS/cm)	± 0,05%

Code	Description
BOE 5290800	BOECO LAC-SP-50 Milk Analyzer, Standard Plastic Model, 50 sec. measuring time, with pH measuring system, USB/RS 232 dataport
BOE 5291860	BOECO LAC-SPA-50 Milk Analyzer, Standard Automat Model 50 sec. measuring time, with pH measuring system and integrated Conductivity measurement, real time clock, USB/RS 232 dataport

Option:
BOE 5451160 High-fat (45%) / Density 1160 kg/m³ measuring function

BOECO MILK ANALYZER LAC-S, LAC-SA

The function of the BOECO Ultrasonic Milk Analyzer is to make quick analyses of milk samples directly after milking, at collecting and during processing.

The BOECO Milk analyzer makes quick analyses of milk and liquid dairy products as: Cow milk, UHT milk, Sheep milk, Goat milk, Buffalo milk, Camel milk, Whey, Cream (up to 45%), Skimmed milk (0,01% FAT, Ice-cream mixtures, Concentrated milk (up to 1160 kg/m³), Yogurt, Flavoured milk, Recovered milk.

Each unit will be delivered with 3 calibrations (standard are sheep, cow and UHT milk)

The standard model LAC-S has one peristaltic pump for the sample. The LAC-SA models have two pumps. The second one for automatic cleaning.

- » Direct measurement of cold milk samples, starting at 5°C
- » No need of periodical calibration
- » The measurement accuracy is not dependant on milk's acidity
- » High-end ultrasonic technology for analyzing any kind of milk
- » Dimensions 100x223x216 mm (WxLxH)
- » Weight: < 3 kg
- » Power: Input 100-240V ~1,6 A max, 50/60 Hz, Output +12V 4.17 A min

The following Parameters can be measured from the Ultrasonic system:
Fat, Solid-non-fat (SNF), Density, Protein, Lactose,
Milk sample temperature, Added water, Salts, Freezing point

The following Parameters can be measured from integrated systems:
pH (together with an electrode), Conductivity, Inhibitors

Parameter	Measuring range	Accuracy
Fat	from 0,01% to 25% (option 45 %)	± 0.1%
SNF (Solids-non-fat)	from 3% to 15%	± 0.15%
Density	from 1015 to 1140 kg/m ³ (option 1160 kg/m ³)	± 0.3 kg/m ³
Protein	from 2% to 7%	± 0,15%
Lactose	from 0.01% to 6%	± 0.15
Added Water content	from 0% to 70%	± 3.0%
Temperature of milk	from 1°C to 40°C	± 1°C
Freezing point	from -0,4 to -0,7°C	± 0.001°C
Salts	from 0,4 to 1,5%	± 0.05%
pH	from 0 to 12	± 0,05%
Total solids	from 0 to 50 %	± 0,17%
Option		
Conductivity	from 3 to 14 (mS/cm)	± 0,05%

Code	Description
BOE 5290090	BOECO LAC-S-50 Milk Analyzer, Standard Model, 50 sec. measuring time, with pH measuring system USB/RS 232 data port, USB flash drive

Option:	Description
BOE 5451160	High-fat (45%) / Density 1160 kg/m ³ measuring function

Accessories

Code	Description
BOE 5290020	Thermal Printer
BOE 5095626	Basic pH combination electrode BA 17, liquid electrolyte, 0...14 pH, 0...100°C, with BNC plug, 1m cable. With leak proof refill opening, platinum diaphragm

USB FLASH
DRIVE



BOECO LAC
SA 50

Results	
F=03.02	S=07.93
D=28.55	P=02.90
L=04.35	W=04.23

Measurement
results

The optional built-in conductivity sensor gives high performance freezing point analysis - avoid poor quality milk due to added water, detects mastitis and falsification with added salt



SHAKER AND STIRRER



V1 PLUS

BOECO VORTEX MIXER V1 PLUS

Vortex mixer V1 plus with variable speed control. Continuous operation as well as with automatic starter, triggered by pressing the attachment. Incl. standard attachment for test tubes up to 20 mm ø.

Specification:

Kind of motion:	orbital, 4 mm
Speed range:	750 - 3000 rpm.
Time of acceleration:	3 sec.
Tube's capacity:	1,5-50ml
Speed display:	scale (min/max)
Switch:	touch / continuous mode
Overall size:	90 x 150 x 80 mm
Weight:	0,8 kg
Power:	12 V. DC 2,0A (External power adapter)

Code

BOE 8055000

Description

Vortex mixer V1plus, AC Adapter 100-240 V with Multi plug (EU, US, UK, AU)

BOECO VORTEX MIXER V2H

Heavy Vortex high speed mixer with brushless motor, digital display and optional attachments.

Specification:

Motor:	brushless DC motor
Kind of motion:	orbital, 4 mm
Speed range:	300 - 4200 rpm. / speed accuracy: ± 10 rpm
Max. loading capacity:	500 g
Display:	digital speed / time setting
Switch:	ON / OFF / Touch
Pulse mode (default):	vibration for 5 secs. than pause for 5 secs.
Pulse mode (programm)	vibration time & pause time can be defined by user between 1 to 99 secs.
Timer	1 to 999 mins. & continuous mode
Overall size:	205 x 136 x 138,5 mm
Weight:	2,8 kg
Power:	external power adapter, 1.6A

Code

BOE 8062000

BOE 8062001

BOE 8062003

Description

Vortex mixer V2H, with standard Vortex cup
AC adapter 100-240 V, 50/60 Hz

Microplate/Microtube (20x1,5/2,0ml)
attachment

Erlenmeyer flask attachment



V2H



BOECO COMBI-SPIN, FVL-2400N PLUS

this combination of a centrifuge and a vortex mixer for Micro test tubes is specially designed for the genetic engineering researches (especially for PCR-diagnostics experiments). It can be used also in biochemical clinical laboratories as well as microbiological and industrial biotechnology laboratories. Combi-Spin ensures the possibility for the simultaneous mixing and separation of the samples, using centrifuge and mixing modules

Specification:

Rotation speed (constant):	2800 rpm (50 Hz), 3500 rpm (60 Hz)
Max RCF:	450 x g (50 Hz), 700 x g (60 Hz)
Continuous operation time:	< 60 min
Accessories included:	1 rotor for 12 x 1,5 ml 1 rotor for 12 x 0,5 and 0,2 ml
Overall size:	190 x 235 x 125 mm
Weight:	1,7 kg

Code	Description
BOE 8071000	Combi-Spin, FVL-2400N plus, 220 V, 50/60 Hz
BOE 8071100	Combi-Spin, FVL-2400N plus, 110 V, 60 Hz
BOE 8071001	SR-16, rotor for 2 x 8-well 0,2 ml microtest strips
BOE 8071002	SR-32, rotor for 4 x 8-well 0,2 ml microtest strips



COMBISPIN
FVL-2400N PLUS

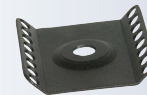

SR-16

BOECO ROTATOR BIO RS-24

Mini-rotator with vertical rotation of the platform for soft mixing of test tubes, microtubes and vacutainers.

Incl. Standard platform PRS-22 for 22 tubes up to 15 mm diam.

Specification:

Speed range:	5 - 30 1/min
Digital Timer:	from 1 min to 23 h 59 min / non-stop
Overall size:	325 x 180 x 155 mm
Weight:	1,4 kg
Power:	12 V. DC 2,0A (External power adapter)

Code	Description
BOE 8024000	Rotator Bio RS-24, with platform PRS-22, AC Adapter 100-240 V with Multi plug (EU, US, UK, AU)
BOE 8073001	Platform PRS-4/12 (4x30 mm diam. and 12x15 mm)



RS-24

BOECO BLOOD TUBE ROTATOR BTR 16

our compact designed BTR 16 with its circular rotating action gives gentle but effective mixing. It can accommodate up to 16 tubes (4 ESR tubes & 12 blood collection tubes) The tubes are easy to fix and remove.

The BTR 16 has a robust construction with a strong metal frame design

Specification:

Capacity:	16 Tubes (12 Blood collection Tubes + 4 ESR Tubes)
Motor:	AC Synchronous motor for noiseless operation
Speed:	Fixed Speed of 30 rpm with an accuracy of ± 2
Run Time:	Continuous / Infinite
Angle of Disc Plate:	Fixed angle of 38°
Maximum operational weight capacity:	1,5 kg
Protection class:	IP 21
Dimension (W x D x H):	278 x 252 x 183 mm
Weight:	1,4 kg

Code	Description
BOE 8026000	Blood Tube Rotator BTR 16, 220 V, 50/60 Hz
BOE 8026100	Blood Tube Rotator BTR 16, 110 V, 60 Hz

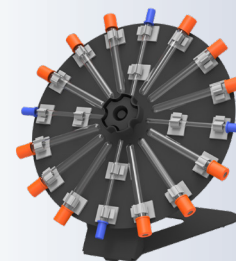

BTR-16

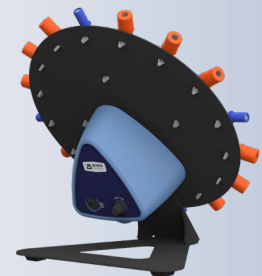

BOECO SUNFLOWER MINI-SHAKER 3D

Mini-Shaker 3D with adjustable speed and constant angle of mixing. Very small and ideal for private diagnostics. Incl. black non-slip silicone mat.



3D

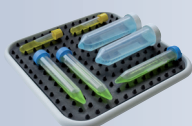

DIMPLED MAT

Specification:

Kind of motion:	three-dimensional orbital movement
Angle:	7°
Speed range:	50 - 60 rpm
Speed display:	scale (min/max)
Platform size:	215 x 215 mm
Overall size:	235 x 235 x 140 mm
Max Loading:	1 kg
Weight:	1,3 kg
Power:	12 V. DC 2,0A (External power adapter)

Code

BOE 8058000

Description

Sunflower Mini Shaker 3D, AC Adapter
100-240 V with Multi plug (EU, US, UK, AU)

BOE 8050200

Dimpled mat

BOECO TUBE ROLLER TR-6

the microprocessor controlled BOECO TR-6 provides gentle rocking and rolling motion. The user can define programs (speed & time) and its Pulse mode provides a momentary pause for through mixing (Pulse can be set for a range of 30 sec. to 90 sec. time) The rollers are fully autoclavable and easy to remove which could allow to use bigger tubes.

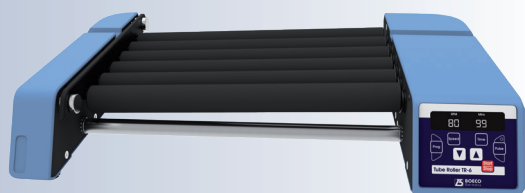

TR-6

Specification:

Housing:	Plastic (ABS)
Motion:	Rolling & Rocking
Tilt angle:	± 3°
Motor:	Brushless DC motor
Speed range:	10 - 80 rpm / 1 rpm
Speed display:	LED
Timer:	1 minute to 99 min. / non-stop
Roller:	6 Rolls / 5 positions (Nylon - autoclavable)
Roller Length:	327 mm
Max Loading capacity:	2 kg
Protection class:	IP 21
Permissible ambient temp.:	4°C to 50°C
Permissible rel. humidity:	<80°C
Input voltage:	100-240 VAC, 50/60 Hz
Output voltage:	24VDC
Overall size:	505x293x90 (WxDxH)
Weight:	approx. 4,2 kg

Code

BOE 8025000

Description

Tube roller TR-6, AC adapter 100-240 V, 50/60Hz

BOECO MAGNETIC STIRRER MMS 3000

Motor drive magnetic stirrer, with stainless steel plate and speed regulation up to 3000 rpm. An optional to be ordered detachable support rod allows to fix different sensors (temperature, pH etc.) inside the Liquid.

Specification:

Speed range:	0 - 3000 1/min
Max. stirring volume:	up to 20,0 l
Platform size:	160 mm diam.
Platform material:	stainless steel
Support rod height:	320 mm
Overall size:	185 x 230 x 75 mm
Weight:	1,5 kg
Power:	12 V. DC 2,0A (External power adapter)

Code	Description
BOE 8056500	Magnetic stirrer MMS-3000, AC Adapter 100-240 V with Multi plug (EU, US, UK, AU)
BOE 8056501	Detachable support rod



MMS 3000



BOECO MAGNETIC STIRRER WITH CERAMIC HOTPLATE HSC-400

Our analog hot plate stirrer with a square ceramic heating plate. Resistant, safe and reliable. The ideal solution for basic heating and stirring application. You can rely on the BOECO HSC-400 for everyday laboratory applications, as it stirs volumes up to 15 liters (H₂O).

The BOECO HSC-400 is equipped with a cutting-edge Heating Plate technology that ensures temperature homogeneity, thermal efficiency and durable heating performance over time.

The BOECO HSC-400 stirs aqueous solutions from 50 up to 1300 rpm being a suitable solution for general laboratory applications performed in chemistry and biology in academia and laboratories.

The BOECO HSC-400 provides LED Indicators for Heating and Stirring.

Specification:

Housing material:	Technopolymer
Hot platform size:	180x180 mm (7x7 in)
Hot platform material:	Ceramic
Stirring speed range:	50 - 1300 rpm
Speed control:	Analog
Stirring volume (H ₂ O):	15 L
Motor:	Monophase PCM
Temperature range:	Room temperature to 400°C
Heating control:	Analog
Power input:	800 W
Permissible ambient temp.:	40°C
Dimensions (WxHxD):	203 x 94 x 233 mm
Weight:	3,4 kg

Code	Description
BOE F20500552BO	Magnetic stirrer with hotplate HSC-400, 220 V
BOE F20510552BO	Magnetic stirrer with hotplate HSC-400, 110 V



HSC 400

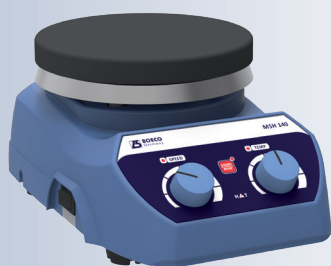

MSH 140



MSH 140 DIGITAL



500 ML REACTION BLOCK

BOECO MAGNETIC STIRRER WITH HOTPLATE MSH 140, MSH 140 DIGITAL

Motor drive Magnetic stirrer with ceramic coated stainless steel hot plate for simultaneously stirring and heating of chemical reagents. „Hot-Surface“ alert indicator light when the plate temperature exceeds 50°C

Specification:	MSH140 digital	MSH140
Over all dimensions (LxBxH) (mm)	156x248x104	156x248x104
Set-up plate dimensions (mm)	140	140
Stirring quantity in Ltr (max)	10	10
Number of stirrer positions	1	1
Setup plate feature (Coating)	ceramic coated stainless steel plate	
IP Rating	IP 21	IP 21
Product weight (kg)	2,3	2,3
Safety temp circuit	Yes	no
Safe temp. (°C)	345	no
Power supply	110/240VAC	110/240VAC
Maximum bar size (mm)	25 - 60	25 - 60
Speed range (rpm)	200 - 2200	200 - 2200
Heating temp. range (°C)	320	320
Hot surface alert (°C)	50	50
Control		
Time range	1 to 999 minutes & continuous	no
Motor type	DC	DC
Motor rating input & Output (W)	5-7	5-7
Accuracy in RPM (+/- RPM)	+/-80	-
speed step	10	-
Heat Output (W)	600	300
Power output (W)	610	310
Temp Accuracy [+/-K]	1	-
Temp increment	1	-
Temp indication	yes	no
Permissible ambient temp (°C)	5-40	5-40
Error code Display	yes	no
Housing Material	ABS	ABS
Display	Yes	no

Code	Description
BOE 8014000	Magnetic stirrer with hotplate MSH 140, 240V
BOE 8014001	Magnetic stirrer with hotplate MSH 140, 110V
BOE 8014110	Magnetic stirrer with hotplate MSH 140 digital, 240V
BOE 8014111	Magnetic stirrer with hotplate MSH 140 digital, 110V

Accessories for MSH 140 digital

Code	Description
BOE 8014120	Support stand with boss head clamp for PT 1000 sensor probe
BOE 8014121	PT 1000 sensor
BOE 8014122	Reaction block, 500 ml

BOECO OVERHEAD STIRRERS OST-25 / OST-40

- » With digital display
- » Compact size
- » Brushless DC maintenance free long life motor
- » The speed will remain constant even with changing viscosities
- » Suitable for viscosities 10.000 and 30.000 mPas and volumes (25/40l)

Technical details	OST-25	OST-40
Stirring quantity (H ₂ O):	25 l	40 l
Max. viscosity:	10.000 mPas	30.000 mPas
Motor rating input/output:	59 W / 45 W	
Output at stirring shaft:	42 W	
Max. ON-time	100%	
Max. torque at chuck (100rpm)	20 Ncm	40 Ncm
Speed range	50 - 2.000 rpm	50 - 1.000 rpm
Speed display:	digital (LED)	
Speed control:	stepless	
Setting accuracy speed:	± 1 rpm	
Reversible direction of rotation:	yes	
Power intermittent operation	yes, (resumes from last run)	
Chuck range:	0,7 - 10 mm	
Extension arm diameter:	13 mm	
Length of extension arm:	160 mm	
Timer (LED):	Yes	
Timer setting range:	1 min - 99 hr 59 min & continuous.	
Protection class:	IP 54 (acc. to DIN EN 60529)	
Protection:	Overload, overcurrent, overtemperature	
Voltage:	100-240 V	
Frequency	50/60 Hz	
DC voltage:	24 V	
Housing material	Thermoplastic polymer	
Dimensions in (WxHxD):	79 x 173 x 176 mm	
Net weight:	approx. 1,4 kg	

Code	Description
BOE 8901170	BOECO overhead stirrer OST-25, 100-240V, 50/60 Hz, package , incl. plate stand (220x320mm/ shaft length 550mm/ diameter 10mm), boss head clamp and 4-bladed propeller stirrer
BOE 8901180	BOECO overhead stirrer OST-40, 100-240V, 50/60 Hz, package , incl. plate stand (220x320mm/ shaft length 550mm/ diameter 10mm), boss head clamp and 4-bladed propeller stirrer



PACKAGE WITH PLATE STAND,
BOSS HEAD CLAMP AND 4-BLADED PROPELLER
STIRRER INCLUDED



MR-1

BOECO MINI-ROCKER SHAKER MR-1

provides gentle rocking motion. It is perfect for soft mixing of biological components. Incl. black non-slip silicone mat

Specification:

Kind of motion:	rocking with fixed 7° angle
Speed range:	5 - 30 rpm
Speed display:	scale (min/max)
Timer:	digital, 1 min - 23h 59min / non-stop
Platform size:	215 x 215 mm
Overall size:	220 x 205 x 120 mm
Max Loading:	1 kg
Weight:	2,1 kg
Power:	12 V. DC 2,0A (External power adapter)

Code

BOE 8058500

Description

MR-1, Mini-rocker Shaker, AC Adapter 100-240 V with Multi plug (EU, US, UK, AU)

BOECO ROTATOR MULTI BIO RS-24

is an intelligent rotator for soft mixing microtubes and vacutainers. The BioRotator RS-Multi provides 3 types of motion, which can be used separately (except for vortex mode, which works in conjunction with reciprocal motion mode) and consecutively in a cycle:

1. Orbital motion



simple even circular motion - common type of motion used in Rotators. Adjustable speed from 1 to 100 rpm.

2. Reciprocal motion



vertical rotation with changing direction of rotation. Adjustable turning angle (from 1° to 90°, increment 1°) sets the limits for this type of motion. The speed is the same as set for rotational motion (from 1 to 100 rpm). In this type of motion there is a pause function (from 0 to 5 sec., increment 1 sec.) settable in the Vortex/pause mode.

3. Vortex motion



intensive mixing of samples at high speed with small amplitude - Vortex motion. The vortex mode is necessary for intensive mixing in and it is provided to decrease adhesion of solutions with tube surface, which is especially important for conducting microquantity research when the sample weight may be equal to the adhesion force. The vortex, mode has an adjustable turning angle of 0° to 5° (increment 1°) and the timer has a pause function from 0 to 5 sec., increment 1 sec.)

Specification:

Standard platform capacity:	PRS-26 for 26 (Microtubes and vacutainers)
Power:	12 V. DC 2,0A (External power adapter)
Size:	365 mm x 195 mm x 155 mm
Weight:	1,8 kg

Code

BOE 8073000

Description

Rotator Multi Bio RS-24, with platform PRS-26 AC Adapter 100-240 V with Multi plug (EU, US, UK, AU)

BOE 8073002

Platform PRS-5/12 for tubes (5 x 30 mm diam. and 12 x 15 mm diam.)

BOE 8073003

Platform PRSC-10 for tubes 10 x 50 ml (Tube Diam 20-30 mm)

BOE 8073004

Platform PRSC-22 for tubes 22 x 15 ml (Tube Diam 10-16 mm)

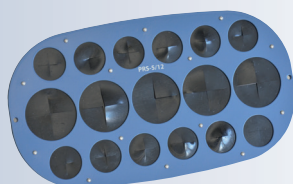
ROTATOR
MULTI BIO RS-24

PRS-5/12



PRSC-10



PRSC-22

BOECO MICROPLATE SHAKER PSU-2T

Specially designed for medical diagnostic. Orbital shaking platform IPP-2 with a holding mechanism for 2 standard microtiter plates.

The use of direct drive and brushless motor allows continuous mixing up to 7 days and ensures reliable, trouble-free operation.

The variable speed control provides an optimally adapted speed range from 150 to 1200 rpm with an orbit of 2 mm.

Specification:

Orbit size:	2 mm
Speed range:	150 - 1200 1/min
Speed display:	scale (min/max)
Timer:	digital, 1 min - 23h 59min / non-stop
Overall size:	220 x 205 x 90 mm
Weight:	2 kg
Power:	12 V. DC 2,0A (External power adapter)

Code

Description

BOE 8052000	Microtiter Plate Shaker PSU-2T, incl. platform IPP-2 AC Adapter 100-240 V with Multi plug (EU, US, UK, AU)
BOE 8052002	Platform IPP-4 for 4 Microtiter Plates



PSU-2T



PLATFORM IPP-4

BOECO MICROPLATE INCUBATOR SHAKER PST-60 HL

The PST-60 HL shakers provide orbital shaking of the samples and have a heating platform for 2 x 96 or 4 x 96 wells microplates and an upper heating lid. The display indicates simultaneous set and actual time, temperature and shaking speed. The PST-60 HL are ideal for a variety of cytochemistry, immunochemistry, biochemistry and research applications.

Specification:

PST-60 HL

PST-60 HL 4

Temperature regulation range:	25°C 60°C	
Temperature setting resolution:	0,1°C	
Temp. Stability:	± 0,1 °C	
Temp. Uniformity over the platform:	± 0,25 °C	
Time of thermoblock heating from RT till 37°C:	12 min.	
Orbit :	2 mm	
Max. height of micotest plate:	18 mm	
Speed regulation:	250 –1200 rpm / increment 10 rpm	
Timer with sound signal:	1 min - 96 hrs, increment 1 min	
Power (external) :	DC 12 V. 5 A	
Platform dimensions:	250 x 150 mm	210 x 290 mm
Number of microplates:	2	4
Size :	270x260x125 mm	380x390x140 mm
Weight incl. power supply :	6,1 kg	9,1 kg

Code

Description

BOE 8072000	Microplate Incubator Shaker PST-60 HL, for 2 plates, AC 100-240 V, 50/60 Hz
BOE 8072040	Microplate Incubator Shaker PST-60 HL 4, for 4 plates, AC 100V-240 V, 50/60 Hz



PST-60 HL



PST-60 HL 4



OS-20 ILLUSTRATED WITH
PP-4 PLATFORM

BOECO UNIVERSAL ORBITAL SHAKER OS-20

Compact, low-profile, orbital laboratory shaker for versatile applications in the fields of biotechnology, microbiology and medical diagnostics. The OS-20 provides gentle rotational mixing and precise circulation at each point of the platform. Variable digital displayed speed control from 50-250 rpm. Digital timer for setting a time interval and continuous operation.

Specification:

Kind of motion:	orbital
Orbit size:	20 mm
Speed regulation:	50 - 250 rpm
Speed display:	digital (LED)
Timer:	from 1 min to 999 min / continuous
Time display:	digital (LED)
Max. load:	2,5 kg excl. attachment
Power:	12 V. DC 2,0A (External power adapter)
Overall size :	265 x 270 x 70 mm (w/o attachment)
Weight:	3,3 kg

Code

BOE 8059000

Description

Universal Orbital Shaker OS-20, AC Adapter 100-240 V with Multi plug (EU, US, UK, AU)



PSU-10i ILLUSTRATED WITH
UP-12 PLATFORM

BOECO UNIVERSAL ORBITAL SHAKER PSU-10i

Equipped with the direct drive system and brushless motor, our compact, powerful and quiet microprocessor controlled orbital laboratory shaker for many general purpose shaking applications. Speed and time setting are easy and during operation the LCD status display clearly indicates both set and actual speed, plus set and elapsed time.

Specification:

Kind of motion:	orbital
Orbit size:	10 mm
Speed regulation:	50 - 450 rpm
Speed display:	digital (LCD)
Timer:	from 1 min to 96 hours / continuous
Time display:	digital (LCD)
Max. load:	3 kg excl. attachment
Power:	12 V. DC 2,0A (External power adapter)
Overall size:	220 x 205 x 90 mm (w/o attachment)
Weight:	3,2 kg

Code

BOE 8069200

Description

Universal Orbital Shaker PSU-10i, AC Adapter 100-240 V with Multi plug (EU, US, UK, AU)

ACCESSORIES FOR OS-20 AND PSU-10i

PLATFORM PP-4

Code

BOE 8059001

Description

Dish platform PP-4 with silicone mat for Petri dishes, culture flasks etc. 235 x 235 mm

PLATFORM UP-12

BOE 8059002

Universal platform UP-12 for all kind of flasks 285 x 215 mm, stainless steel with variable clamping rolls and silicone mat.

Numbers of flasks at the platform

100- 150 ml flasks max 12-9 pieces

200- 250 ml flasks max 6-4 pieces

500-1000 ml flasks max 4-2 pieces

PLATFORM P-6/250

BOE 8059003

Platform P-6/250 with fixed clamps for 6 flasks 250/300 ml, 250 x 190 mm

PLATFORM P-12/100

BOE 8059004

Platform P-12/100 with fixed clamps for 12 flasks 100/150 ml, 250 x 190 mm

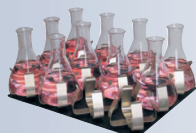
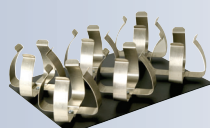

BOECO PROGRAMMABLE ORBITAL SHAKER PSU-15i

The PSU-15i belongs to a generation of multifunctional mixing devices: The design, direct drive system, brushless motor (service life up to 35000 hours) and automatic loading balancing system make the PSU-15i even more reliable especially for the long non-stop operation. The PSU-15i has a microprocessor control which allows real-time program correction, indication of set and actual speed, angle and time, operation timer in the display.

1. Orbital motion



simple even circular motion - common type of motion used in shakers. Adjustable speed from 20 to 250 rpm.

2. Reciprocal motion



vertical rotation with changing direction of rotation. Adjustable turning angle (from 0° to 360°, increment 30°) sets the limits for this type of motion. The speed is the same as set for rotational motion (from 20 to 250 rpm).

3. Vortex motion of the platform (vibration)



intensive mixing of samples at high speed with small amplitude - Vortex motion. Adjustable turning angle of 0° to 5° (increment 1°)

Specification:

Kind of motion:	orbital
Orbit size:	20 mm
Speed regulation:	20 - 250 rpm
Speed display:	digital (LCD)
Timer:	from 1 min to 96 hours / continuous
Time display:	digital (LCD)
Max. load:	8 kg
Continuous operation time:	max 168 hrs.
Power (external):	DC 12 V. 3,2 A
Overall size (w/o platform):	410 x 410 x 130 mm
weight:	11,6 kg

Code

Description

BOE 8079000	Orbital Shaker PSU-15i, 100-240 VAC/12DC 4,16A without platform
-------------	---

Accessories

Code

Description

BOE 8079010	Universal platform UP-330 for all kind of flasks 430 x 330 mm, stainless steel with 4 variable clamping rolls and rubber mat
BOE 8080011	Flat platform PP-20, 480 x 380 mm
BOE 8080012	4 level platform PP-20-4, 480 x 380 x 170 mm Distance between platforms: 170 mm Total height: 510 mm
BOE 8080005	Universal tray platform, 360 x 360 mm with holes to accommodate clamps for Erlenmeyer flasks, separating funnels and test tube racks Clamps have to be ordered separately
BOE 8081001	Spring clamp, 25 ml max.: 36 pcs.
BOE 8081002	Spring clamp, 50 ml max.: 36 pcs.
BOE 8081003	Spring clamp, 100 ml max.: 25 pcs.
BOE 8081004	Spring clamp, 250 ml max.: 16 pcs.
BOE 8081005	Spring clamp, 500 ml max.: 9 pcs.
BOE 8081006	Spring clamp, 1000 ml max.: 9 pcs.
BOE 8081007	Spring clamp, 2000 ml max.: 4 pcs.
BOE 8081009	Holding device for Separating funnels 250-1000 ml



PSU-15i WITH PLATFORM UP-330



PSU-15i WITH TRAY PLATFORM



PP-20



PP-20-4

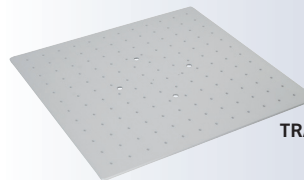

TRAY PLATFORM

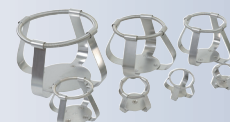

SPRING CLAMPS



HOLDING DEVICE FOR SEPARATING FUNNELS



BOECO ORBITAL SHAKER INCUBATOR ES-20/80

Our BOECO ES-20/80 shaker-incubator for biotechnological and pharmaceutical laboratories is a professional category equipment. The typical applications include microbiological and cell culture cultivation, protein expression, solubility studies, general mixing, as well as other various applications in the fields of biology and chemistry. The unit is equipped with a newly developed triple eccentric mechanism for platform motion that provides supreme balancing characteristics, superior reliability and quiet operation. The achieved stability of the unit during vigorous mixing allows for stacking installation of up to 3 units which enables to save space. The new display and easy to use user interface provide a clear and intuitive control of parameters and also allow data logging, storage and display over time. Additional features like out of balance sensor and automatic thermostat failure detection make this shaker-incubator an advanced and safe product. Bluetooth connectivity to PC allows for data management, data logging, parameter control and profiling in a dedicated software that can be requested separately.

A built-in heat-resistant brushless fan provides precise temperature distribution inside the chamber (from 10°C above ambient up to +80°C). Additionally, excellent sample temperature uniformity of ± 0.3 °C at 37 °C is achieved. The inner chamber is made of stainless steel. State-of-the-art motor, thermal insulation materials and parameter PID-control decrease the energy consumption and make the shaker-incubator highly energy efficient despite its relatively large size.

Specification:

Speed control range	50–400 rpm (increment 10 rpm)
Digital time setting	1 min–96 hrs / non–stop (1 min increment)
Maximum continuous operation time	30 days
Maximum load	10,6 kg
Orbit	20 mm
Stacking	up to 3
Display	TFT
Data transfer	Bluetooth
Temperature setting range	+25°C... +80°C (increment 0,1°C)
Temperature control range	10°C above ambient... +80°C
Sample temperature uniformity	$\pm 0,3$ °C at 37°C
Temperature precision	$\pm 0,1$ °C at 37°C
Temperature accuracy	$\pm 0,1$ °C at 37°C
Sample temperature stability	$\pm 0,1$ °C at 37°C
Heat up time to max. temperature	75 min
Overall dimensions (WxDxH)	620 × 530 × 510 mm
Dimensions of the inner chamber	460 × 350 × 400 mm
Weight	48 kg
Nominal operating voltage	230 V, 50/60 Hz or 120 V, 50/60 Hz
Power consumption	230 V / 450 W (2 A) 120 V / 450 W (4.5 A)

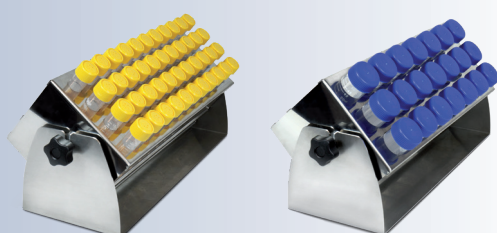
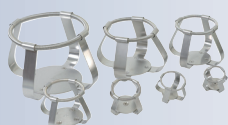

Code	Description
BOE 8086000	Orbital Shaker Incubator ES 20/80 230V, 50/60Hz, without platform
BOE 8086100	Orbital Shaker Incubator ES 20/80 120V, 50/60Hz, without platform

Accessories

Code	Description
BOE 8086400	Platform PP-400 360 x 400 mm with silicone mat
BOE 8080005	Universal tray platform 360 x 360 mm clamps have to be ordered separately
BOE 8082003	Tight fit clamp, 100 ml max.: 25 pcs.
BOE 8082004	Tight fit clamp, 250 ml max.: 16 pcs.
BOE 8082005	Tight fit clamp, 500 ml max.: 9 pcs.
BOE 8082006	Tight fit clamp, 1000 ml max.: 9 pcs.
BOE 8086015	Test tube rack TR-44/15 for 44 x 15 ml tubes
BOE 8086050	Test tube rack TR-21/50 for 21 x 50 ml tubes

BOECO DESKTOP INCUBATOR I-18 BOECO UNIVERSAL DESKTOP OVEN U-18

The I-18/U-18 are featured with unique design, modern appearance, and advanced manufacturing techniques. They have an accurately temperature control system, daily maintains and operates easily. Those Incubator/Oven are widely used in bacteria & microbial scientific research, medical science, pharmacy, biological and biochemical industries etc

Features:

- » Vertical design, box body made by high quality cold-rolled steel, the surface is treated by electrostatic spraying process, stable and beautiful appearance.
- » LCD fuzzy-PID control temperature controller with overtemperature protection
- » Stainless Steel inner chamber, Circular arc transition corners, adjustable shelf, and easy cleaning.
- » The external chamber is processed by cold rolling steel plate after anti-corrosive coating.
- » Door with double toughened glass window enables large angle observation. Elastic adjustable lock type handle. High temperature silica gel sealing strip, to ensure good sealing and prevent heating loss.

Specification I-18:

Volume:	18 l
Heating power:	200W
Operating Temp. Range:	Room Temperature + 5°C... + 65°C
Temp. Uniformity:	± 0,5
Temp. Fluctuation:	± 0,5
Temperature Setting:	0,1°C
Time range:	1 -9999min, continuous.
Max. Number of shelves:	2
Shelf Load:	15 kg
Internal Dimension:	260 x 260 x 260 mm (L x W x H)
External Dimension:	460 x 510 x 695 mm (L x W x H)
Weight net:	16,3 kg

Code	Description
BOE 8042000	BOECO Desktop Incubator I-18, 220 V, 50/60 Hz incl. 2 stainless steel shelves
BOE 8042100	BOECO Desktop Incubator I-18, 115 V, 60 Hz incl. 2 stainless steel shelves

Specification U-18:

Volume:	18 l
Heating power:	600W
Operating Temp. Range:	Room Temperature + 10°C... + 300°C
Temp. Uniformity:	± 0,5
Temp. Fluctuation:	± 0,5
Temperature Setting:	0,1°C
Time range:	1 -9999 min, continuous.
Max. Number of shelves:	2
Shelf Load:	15 kg
Internal Dimension:	260 x 260 x 260 mm (L x W x H)
External Dimension:	460 x 510 x 695 mm (L x W x H)
Weight net:	16,4 kg

Code	Description
BOE 8043000	BOECO Universal Desktop oven U-18, 220 V, 50/60 Hz incl. 2 stainless steel shelves
BOE 8043100	BOECO Universal Desktop oven U-18, 115 V, 60 Hz incl. 2 stainless steel shelves





BOECO COMPACT CO2 INCUBATOR S-BT

S-Bt Smart Biotherm is designed for work in the areas of cell biology (operations with animal cell cultures and tissues), molecular biology (DNA/RNA reaction analysis, hybridization reactions), biotechnology (synthesis of target proteins and other molecules), immunology (synthesis of antibodies and other proteins of immune system).

Features:

- » Six-sided heating: The heating elements are located on the walls and on the door, thus providing excellent uniform temperature distribution, regardless of external factors, such as ambient temperature and positioning of the device.
- » Built-in infrared CO₂-sensor allows an accurate control of the CO₂ level. The sensor makes measurement non-sensitive to changes in temperature and humidity inside the incubator.
- » The chamber is made of stainless steel with smoothed seams to minimize contamination and to facilitate cleaning.
- » The BOECO S-Bt is equipped with a UV air recirculation system - one UV lamp and a fan are mounted behind the rear wall, providing decontamination of the working volume.
- » A convenient access port is built in the wall of the incubator for easy output of wire sensors or devices' installed inside. The access port is heated independently to prevent formation of condensate.
- » An error tracing and alarm system lowers significantly potential risks during operation.
- » The unit is equipped with a "black box" system that records temperature, humidity and CO₂ levels, as well as statuses for door opening, UV lamp, fan and errors, to the inner memory.
- » Bluetooth connection to PC is available as an option.

Technical details:

Working chamber material	Stainless Steel (1 mm)
Temperature setting range	+25°C ... +60°C
Temperature stability	±0.1°C
Temperature uniformity at +37°C	±0.3°C
Working volume	46 litres
Number of shelves	3 (max. 6)
Inner glass door	yes
Relative humidity	>90% @ 37°C
Humidity delivery	Water Pan
CO ₂ control range	0 – 20%
CO ₂ sensor	Infrared CO ₂ sensor
Temperature and CO ₂ level input	Digital
UV lamp	1 × 6 W, TUV G6T5
Data output	Wireless
Access port	1 (ø 26 mm)
Dimensions	400 × 410 × 580 mm
Weight	37,7 kg
Nominal operating voltage	230 V, 50/60 Hz 115 V, 60 Hz

Code	Description
BOE 8087000	BOECO compact CO ₂ incubator, 230 V, 50/60 HZ
BOE 8087100	BOECO compact CO ₂ incubator, 115 V, 60 Hz

Accessories

Code	Description
BOE 8087001	Additional shelf
BOE 8087002	PC Software and Bluetooth adapter
BOE 8087003	Incubator stacking device

BOECO AUTOCLAVE BTE-23D

Features:

- » Three times fractionated pre-vacuum
- » Stainless steel chamber
- » LCD display
- » Equipped with high quality and high performance pump
- » 1 tray holder, 1 tray handle and 3 trays included
- » High quality water pump and valves
- » Independent steam generator
- » Two samples self-calibration
- » Overhead type water storage tank, easy to clean
- » Drying procedure: Dry by vacuum
- » Sterilization temperature: 121°C and 134°C
- » Test programs: Helix test, B&D test and Vacuum test
- » Sterilization cycles: 9 cycles are available and 3 test programmes.

Program	Temperature	Pressure	Sterilization time	Total time
SOLID 134	134°C	2.1 bar	4 min	25-45 min
SOLID 121	121°C	1.1 bar	20 min	35-60 min
LIQUID 134	134°C	2.1 bar	10 min	35-60 min
LIQUID 121	121°C	1.1 bar	30 min	35-65 min
WRAPPED 134	134°C	2.1 bar	4 min	35-60 min
WRAPPED 121	121°C	1.1 bar	20 min	35-65 min
TEXTILE 134 (or wrapped)	134°C	2.1 bar	6 min	45-65 min
TEXTILE 121 (or wrapped)	121°C	1.1 bar	20 min	50-70 min
PRION	134°C	2.1 bar	18 min	45-70 min
B&D TEST	134°C	2.1 bar	3.5 min	22-35 min
Helix TEST	134°C	2.1 bar	3.5 min	22-35 min
Vacuum TEST	-	-	-	15-20 min

- » It only have several buttons, very easy to use, any people can run it easily.
- » All cycles are fully automatic; there is no need for human intervention in cycle management.
- » Pressure protection locking system that ensures the door will not be opened once there is any pressure in chamber.
- » Sterilization documentation: Integrated Micro Printer and USB port to store the information of the programme cycle in flash memory.
- » The sterilization time and dry time can be adjusted by manual, ensure user to obtain best sterilization effects according to private requirements.
- » Malfunction detection system, corresponding error code will be showed on the display once there is something going wrong.

Safety:

- » Warning system prevents starting a cycle if door is not properly locked.
- » Triple threat protection for overheating and overpressure.
 - The pressure protection system will automatically cut off the electricity supply once the temperature of chamber inside is abnormally. Motorola pressure sensor is used to accurately sense the state of pressure inside chamber.
- Temperature control system is using high quality PT1000 temperature sensor, it is high precision, reliable service and prompt measurement, ensure accurate and timely transmission of temperature fluctuation.
- The safety valve will release steam in case the pressure inside chamber exceeds normal levels.

Technical Information:

- » Conform to CE and EN13060
- » Manufactured under ISO 13485 norms
- » Chamber Size: ø 247 x 450 mm (23 l)
- » External dimension: 490 x 480 x 680 mm, Net weight 50 kg
- » Packing box 750 x 560 x 460 mm, Gross weight 67,5 kg
- » Power: 220 V, 50/60 Hz or 110 V, 60 Hz

Code	Description
BOE 8902300	BOECO BTE-23D Bench Top Autoclave, Vol. 23 l. incl 1 tray holder, 1 tray handle and 3 trays, micro printer and USB port, 220 V, 50/60 Hz
BOE 8902310	BOECO BTE-23D as above but for 110 V, 60 Hz



BOECO BTE-23D

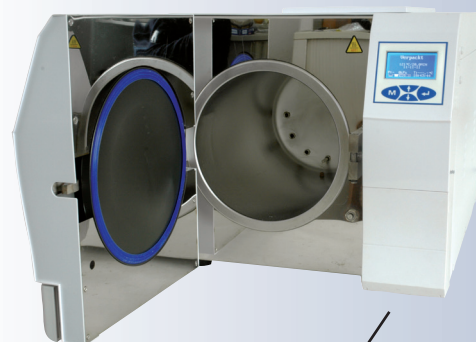

MICRO PRINTER AND USB PORT

This BTE-23D adopts 3 times pre-fractionated vacuum system, the following chart simply describes the status of its process

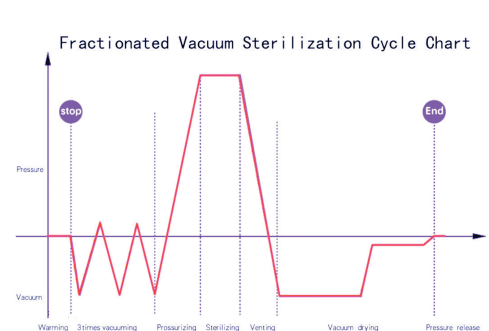

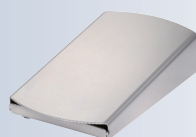

FOOT PEDAL

BOECO FUEGO SCS BASIC SAFETY LABORATORY GAS BURNER

is a new standard among laboratory gas burners. With its innovative design this laboratory gas burner is suitable for all flame related applications in the laboratory.

Specification:

Technology: Microprocessor

Programs

Foot pedal: Standard (flame during pressed foot pedal)
Start-Stop with timer, 60 min

Button: Start-Stop with timer, 60 min

Safety features

Safety Control System (SCS) with gas safety cut off:

ignition and flame control
temperature monitor
burner head clogging
and assembly monitor (BHC)
automatic unit switch off, 4 h
residual heat display

Gas supply and consumption

Gas connection: 1/4" left with gas filter
Gas types: natural gas E/LL, 18 - 25 mbar
liquid gas I12ELL3B/P, 20 - 50 mbar
70 g/h liquid gas

Connected load:
Continuous cartridge
operation:

CV 360 - 40 min, Express 444 - 50 min
CG 1750 - 150 min, C 206 - 170 min
CP 250 - 210 min, CV 470 - 370 min

Temperatures

Flame temperature: 1350 °C on liquid gas
1300 °C on natural gas (E)

Electrical

Power consumption: 2VA
Power connection: 100 - 240 V / 50/60 Hz / max. 0,3 A
9 V DC / 1A

Mechanical

Casing and operation
controls: stainless steel / glass,
UV and solvent resistant

Cover of burner shaft:

Size (w x h x d): ø 23 mm, with drains
103 x 49 x 130 mm

Weight:

1,4 kg

Licenses

DIN-DVGW Reg.-No: NG-2211AS0167
CE: EN 61326-1, EN 61010-1
EEC guidelines: 2004 / 108 / EC, 73/23/EEC

Code

Description

BOE 8201000	BOECO Fuego SCS basic, Safety Laboratory gas burner with button function and foot pedal, 3 standard-programs for button (function knob) and foot pedal SCS (Safety Control System) with BHC (Burner Head Control), Removable and decomposable burner head Tild mechanism, right / left, Holding device for 3 inoculation loop holders. Nozzles for natural gas, propane / butane gas, Turbo flame Wrench 17 mm for gas connection, Screwdriver for burner head and cover of burner shaft. Tubing connector with swivel nut, Switching power supply
-------------	---

Accessories

Code

Description

USB 5431	Inoculation Loop / needle holder, 230 mm,
USB 5460	Inoculation Loop, st. steel wire ø 0,6mm, ø loop 1,5mm
USB 5461	Inoculation Loop, st. steel wire ø 0,6mm, ø loop 2,5mm
USB 5462	Inoculation Loop, st. steel wire ø 0,6mm, ø loop 4,0mm



BOECO WATER BATH PWB-4 AND PWB-8

The personal advanced PID microprocessor controlled waterbath PWB-4 and PWB-8 with their specification, easy operation and small foot print are designed for chemical, pharmaceutical, medical and biological routine laboratory use and as well as for research purpose.

» Control Panel:

Easy setting and operating, adjustable temperature, alarm signal display Single Line 4 digitals LED

» Overheat Protection:

The power will automatically be turned off when the internal temperature is over 110 °C

Specification	PWB-4	PWB-8
Capacity:	4 l	8 l
Temperature Range:	Room Temperature +5°C.. +99,9°C	
Temperature Setting:	0,1°C	
Uniformity:	± 0,2 (37°C)	
Fluctuation of Temp.:	± 0,5°C (RT + 5 - 80°C), ± 0,8 (80 - 99,9°C)	
Heating Time:	≤ 100 min (from 30°C to 95°C at RT 25°C)	
Input Power:	400 W	600 W
Water outlet:	No	Yes
Bath Inner Dimensions: (LxWxH mm)	238x135x146	325x265x150
Outside Dimensions: (LxWxH mm)	380x212x250	445x285x316
Weight (net):	6,5 kg	8 kg

PWB-4

Code	Description
BOE 8036000	Waterbath PWB-4, without lid, 220 V, 50/60 Hz
BOE 8036100	Waterbath PWB-4, without lid, 115 V, 60 Hz

Accessories for PWB-4

Code	Description
BOE 8036001	Gabled plastic lid
BOE 8036002	Flat stainless steel lid with 2 concentric rings
BOE 8036018	Test tube rack st. steel with 41 x 18 mm ø holes
BOE 8036015	Test tube rack st. steel with 41 x 15 mm ø holes
BOE 8036003	Flask tray, stainless steel

PWB-8

Code	Description
BOE 8037000	Waterbath PWB-8, without lid, 220V, 50/60 Hz
BOE 8037100	Waterbath PWB-8, without lid, 115V, 60 Hz

Accessories for PWB-8

Code	Description
BOE 8037001	Gabled stainless steel lid
BOE 8037002	Flat stainless steel lid with 4 concentric rings
BOE 8037018	Test tube rack st. steel with 76 x 18 mm ø holes
BOE 8037015	Test tube rack st. steel with 76 x 15 mm ø holes
BOE 8037003	Flask tray, stainless steel



PWB-8

PWB-4



FLAT LID FOR PWB-4



GABLED PLASTIC LID FOR PWB-4



TEST TUBE RACK FOR PWB-4

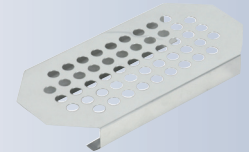

FLASK TRAY FOR PWB-4

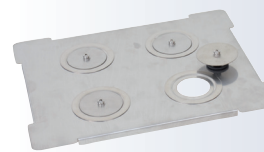

FLAT LID FOR PWB-8



GABLED LID FOR PWB-8



TEST TUBE RACK FOR PWB-8

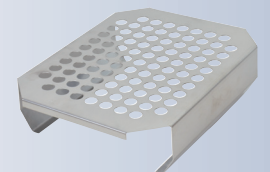

FLASK TRAY FOR PWB-8



MF 8/1100

MF 8/1100
WITH CHIMNEY

BOECO MUFFLE FURNACE MF 8/1100

our new muffle furnace, designed for materials testing, heat treatment, ceramic and stoneware samples firing. The furnace can be used in laboratories, educational institutions, ceramic studios and industrial laboratories.

Standard design of furnace

- » Maximum temperature 1100°C
- » Capacity 8.2 L
- » High thermal efficiency
- » Vacuumed ceramic fiber chamber
- » Heating elements are embedded in fiber
- » High quality thermoinsulation materials
- » Door safety interlock switch
- » Ceramic bottom plate
- » Fast heating time
- » Low power consumption
- » Good stability and uniformity

Control

- » Microprocessor temperature controller (Omron E5CC)
- » Temperature measurement by thermocouple type "K"
- » PID electronic regulator, double digital display reference temperature and measured temperature

Technical details:

	MF 8/1100
Useful volume	8,2 L
Rated power not more than	1.8 kW
Rated supply voltage	230 V
Rated frequency	50/60 Hz
Number of phases	1
Continuous operating Temperature	1100°C
Maximum temperature	1100°C
Working chamber material	Fibre muffle
Maximum heating- up time (without charge)	50 min
Temperature stability in working chamber at rated temperature in thermal steady state without charge not more than	±2°C
Temperature uniformity in working space at rated temperature in thermal steady state without charge not more than	±10°C
Furnace working chamber dimensions	
width	200 mm
depth	300 mm
height	133 mm
Furnace dimensions:	
width	440 mm
depth	620 mm
height	510 mm
Weight (Net)	28 kg

Code	Description
BOE 8641100	BOECO Muffle Furnace, MF 8/1100, 230 V, 50/60 Hz

Code	Description
BOE 8641100/ LHM21	BOECO Muffle Ashing Furnace, MF 8/1100, with Fan-assisted chimney for smoke and humidity extraction, 230 V, 50/60 Hz

BOECO PCR WORKSTATION WITH UV AIR RECIRCULATOR, TYPE UVC/T-AR

For the preparation of PCR reactions and many other methods in molecular biology, a contamination-free working environment is required. The UVC/T-AR PCR Workstation is designed for DNA/RNA decontamination in the laboratory working place.

The UVC/T-AR is a bench top model, constructed from metallic skeleton and plexiglas and has a painted metal working place and a digital timer control of UV exposure. One open 25 W UV-lamp substantially decreases contamination level during UV-exposure (15-30 min).

White 15 W lamp provides local illumination of the working place and ensures good conditions for visual control of operation.

The model UVC/T-AR includes not only traditional UV source for direct lighting the surface of the inner working place of the PCR-box, but also additional UV air flow cleaner (UV - recirculator) for biosafety DNA decontamination to protect the user from direct UV-light during operation.

UV-recirculator consists of a UV lamp, fan and dust filters organized in a special box for maximum increasing (1000 x fold) density of UV-light leading sufficiently to effectivity of DNA inactivation. UV-recirculator generates 100 volumes of the PCR per 1 hour air flow exchange giving maximum aseptic conditions inside the box.

Advantages

No HEPA filters, Ozone free high density UV decontamination
Long living UV lamps (8000 hrs)-No noise, low energy consumption-
Compact bench top for personal labs.

The PCR workstation UVC/T-AR is recommended for labs working in the fields of DNA analysis, genetic engineering, molecular biology.

Specification

Direct UV-lamp light:	TUV 25W G13 UV-C Special Philips
Radiation type:	Ultraviolet (254 nm), ozone free
UV-lamp life time:	9000 hrs
UV-recirculator:	TUV 25W G13 UV-C Special Philips
Digital time setting of direct UV-exposure	1 min - 24 hrs
Luminiescent (visible light lamp)	15W/830 G13 Philips
Plexiglass type:	Polymethylmethacrylate
Optical transmission:	92 %
UV-protection:	99,9%
Thickness of plexiglass sides:	4 mm
Thickness of upper front side:	8 mm
Thickness of protective front screen:	8 mm
Working place:	650x475 mm
Overall size:	690x535x555 mm
Power:	100-240 V, 50/60 Hz, 67 W
Weight:	21,2 kg

Code	Description
BOE 8040000	PCR Workstation UVC/T-AR, 100-240 VAC, 50/60 Hz



UVC/T-AR



DBI-100



DBI-200



DB-01



DB-02



DB-03



DB-4



DB-5



DB-06



DB-07



DB-08



DB-09



DB-10



DB-11



DB-15



DB-16



DB-17



DB-18



DB-20

BOECO DRY BATH BLOCK INCUBATOR DBI-100, DBI-200

are ideal for incubation and activation of cultures, enzyme reactions, blood urea nitrogen determinations, immunoassays, melting/boiling points and a wide variety of laboratory procedures.

A supplied special block extraction tool allows to remove blocks easily.

Specification:

	DBI-100	DBI-200
Model:		
Temperature control range:	RT +5°C - 105°C	
Display Accuracy :	± 0,1°C	
Temperature Stability @100°C	0,4°C	
Uniformity ¹⁾ within the block @37°C	≤ 0,5°C	
Heating Time (20 to 105°C)	less than 15 min	
Timer:	1 min - 99 h 59 min	
Block Quantity:	1	2
Power, max:	120 W	240 W
Size mm :	250x190x130	365x210x150
Weight:	1,8 kg	2,9 kg

Code	Description
BOE 8018000	Dry Block Thermostat DBI-100, 200/240 V 50/60 Hz
BOE 8018100	Dry Block Thermostat DBI-100, 110/120 V 50/60 Hz
BOE 8019000	Dry Block Thermostat DBI-200, 200/240 V 50/60 Hz
BOE 8019100	Dry Block Thermostat DBI-200, 110/120 V 50/60 Hz

Aluminium blocks with conical bottom for microtubes:

Code	Description
BOE 8018001	Block DB 01 for 96 x 0,2 ml PCR tubes
BOE 8018002	Block DB 02 for 45 x 0,5 ml tubes
BOE 8018003	Block DB 03 for 35 x 1,5 ml tubes
BOE 8018004	Block DB 04 for 35 x 2,0 ml tubes
BOE 8018005	Block DB 05 for 15 x 0,5 ml + 20 x 1,5 ml tubes
BOE 8018006	Block DB 06 for 20 x 1,5 ml + 15 x 2,0 ml tubes
BOE 8018007	Block DB 07 for 32 x 0,2 ml + 25 x 0,5 ml + 9 x 1,5 ml tubes

Aluminium blocks with flat bottom:

Code	Description
BOE 8018008	Block DB 08 for 20 x 5 ml tubes Bore size: 14 mm Ø, Depth 40 mm
BOE 8018009	Block DB 09 for 20 x 10 ml tubes Bore size: 16 mm Ø, Depth 47 mm
BOE 8018010	Block DB 10 ²⁾ for 12 x 15 ml tubes Bore size: 16,9 mm Ø, Depth 58,5 mm
BOE 8018011	Block DB 11 ²⁾ for 6 x 50 ml tubes Bore size: 29 mm Ø, Depth 58,5 mm

Aluminium blocks with round bottom:

Code	Description
BOE 8018015	Block DB 15 ²⁾ for 40 x 6 mm Ø tubes Bore size: 6,5 mm Ø, Depth: 33 mm
BOE 8018016	Block DB 16 ²⁾ for 28 x 10 mm Ø tubes Bore size: 10,5 mm Ø, Depth: 47 mm
BOE 8018017	Block DB 17 ²⁾ for 24 x 12 mm Ø tubes Bore size: 12,5 mm Ø, Depth: 47 mm
BOE 8018018	Block DB 18 ²⁾ for 24 x 13 mm Ø tubes Bore size: 13,5 mm Ø, Depth: 47 mm
BOE 8018020	Block DB 20 ²⁾ for 14 x 16 mm Ø tubes Bore size: 16,5 mm Ø, Depth: 47 mm
BOE 8018027	External Sensor, PT 1000

¹⁾ uniformity is measured with a sample height within the block

²⁾ for blocks DB 10, 11 the lid cannot be closed, for blocks DB 15-19 the lid could only be closed if the tube height is less than 80 mm

BOECO THERMO-SHAKER FOR MICROTUBES TS-100

is a compact and cost-efficient solution for shaking and temperature control of small samples in 0,5 ml, 1,5 ml and 2,0 ml microtubes. The TS-100 is microprocessor controlled and has a display which indicates simultaneous set and actual time, temperature and shaking speed.

Specification:

Orbit size:	2 mm
Temperature range:	25°C - 100°C
Speed range:	250 - 1400 1/min, increment 10 rpm
Acceleration time:	3 sec
Timer with sound signal:	digital, 1 min - 96 h increment 1 min
Power (external):	DC 12 V. 5 A
Overall size:	205 x 230 x 130 mm
Weight:	4,0 kg

Code	Description
BOE 8064000	Thermo-Shaker for microtubes TS-100, without block, AC 100-240V 50/60 Hz
BOE 8064001	Interchangeable block, SC-18 for 20x0,5 ml and 12 x 1,5 ml microtubes
BOE 8064004	Interchangeable block, SC-18/02 for 20x0,2 and 12 x 1,5 ml microtubes
BOE 8064005	Interchangeable block, SC-24N for 24x1,5 ml microtubes
BOE 8064007	Interchangeable block, SC-24 for 24x2,0 ml microtubes
BOE 8064006	Interchangeable block, SC-96A for 96-well PCR microplate



TS-100 with block SC-24N

BOECO THERMO-SHAKER FOR MICROTUBES TS-100C

is a heating and cooling thermomixer. Active cooling using Peltier technology offers a temperature regulation range from +4°C to +100°C. Temperature control and mixing modes can be used simultaneously and independently. The TS-100C is microprocessor controlled and has a display which indicates simultaneous set and actual time, temperature and shaking speed. The low voltage power supply enables safe cold room or incubator operation. The TS-100C is applicable for DNA analysis, extraction of proteins, polysaccharids, lipids and other cell components

Specification:

Speed range:	250 - 1400 1/min, increment 10 rpm
Acceleration time:	3 sec
Orbit size:	2 mm
Temperature control range:	15°C below room temp. to +100°C
Temperature setting range:	+4°C to 100°C
Average heating rate:	5°C / min (from +25 to +100°C in 15 min)
Average cooling speed:	From +100°C to +25°C: 5°C / min From +25°C to +4°C: 1,8°C / min
Timer with sound signal:	digital, 1 min - 96 h, increment 1 min
Power (external):	DC 12 V. 5 A
Overall size:	205 x 230 x 130 mm (w x d x h)
Weight:	4,2 kg

Code	Description
BOE 8064050	Thermo-Shaker for microtubes TS-100C, without block, AC 100-240 V 50/60 Hz
BOE 8064051	Interchangeable block, SC-18C for 20x0,5 ml and 12 x 1,5 ml microtubes
BOE 8064054	Interchangeable block, SC-18/02C for 20x0,2 ml and 12 x 1,5 ml microtubes
BOE 8064057	Interchangeable block, SC-24NC for 24x1,5 ml microtubes
BOE 8064055	Interchangeable block, SC-24C for 24x2,0 ml microtubes
BOE 8064056	Interchangeable block, SC-96AC for 96-well PCR microplate



TS-100C with block

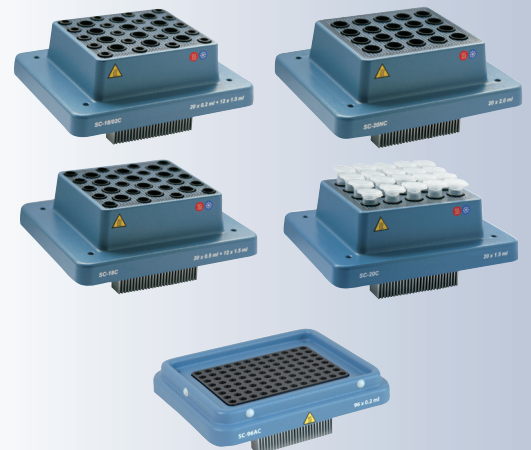



THERMAL CYCLER TC-SQ

BOECO THERMAL CYCLER TC-SQ

is a personal Thermal Cycler with compact structure and small footprint and a friendly user interface with big LCD display which gives reliable results for teaching and research laboratories.

The TC-SQ provides superior performance especially in the cooling and heating speed, temperature control accuracy and uniformity of the block.

Specification:

Sample capacity:	24 x 0,2 ml, 8-strip, 24 x 0,2 ml plate
Temperature control range:	+ 4 ~ +99 °C
Heating rate (max.):	≥ 5,0°C /sec
Cooling rate (max.):	≥ 4,0°C /sec
Block temp. uniformity:	≤ ± 0,5°C
Block temp. accuracy:	≤ ± 0,3°C
Temp. of hot lid:	30°C - 110°C
Adjustability of hot lid press:	Yes
Temp. control mode:	Block or Tube
Display:	320 x 240 LCD
Program storage:	100 files
Max. segments	5 segments
Max. program steps:	16 steps
Max. cycles:	99 cycles
Size:	297 (L) x 212 (W) x 200 (H) mm
Weight:	3,2 kg
Interface:	RS 232

Code	Description
BOE 8085240	Thermal cycler TC-SQ, 220-240 V, 50/60 Hz with sample block for 24 x 0,2 ml
BOE 8085241	Thermal cycler TC-SQ, 100-120 V, 50/60 Hz with sample block for 24 x 0,2 ml

Optional Block:

Code	Description
BOE 8085185	Sample Block for 18 x 0,5 ml

BOECO THERMAL CYCLER TC-TE

is a personal Thermal Cycler with compact structure and small footprint and a friendly user interface with colored 5,7" touch screen and a fixed gradient block for 96 x 0,2 ml which gives reliable results for teaching and research laboratories.

Specification:

Sample capacity:	96 x 0,2 ml, 8-strip, 24 x 0,2 ml plate
Cooling technology:	Peltier
Temperature control range:	+ 4 ~ +99°C
Heating speed of ramping:	up to 4,0°C /sec
Cooling speed of ramping :	up to 4,0°C /sec
Block temp. uniformity:	≤ ± 0,3°C
Block temp. accuracy:	≤ ± 0,1°C (55°C) ≤± 0,2°C (≥90°C)
Display resolution:	0,1°C
Temp. control mode:	Block or Tube
Ramping rate adjustable:	0,1°C - 4°C
Memories:	250 typical programs (unlimited by USB)
Max. cycles:	99 cycles for Nested PCR
Time up/down:	0-9 min59s, suit for LongPCR
Temperature up/down:	0,1 - 9,9°C suit for TouchdownPCR
Soak function:	Yes
Gradient range:	30°C ~ 99°C
Temp. differential range:	1°C ~ 30°C
Temp. of hot lid:	30°C -110 °C (Temp. / pressure adjusted)
Size:	335 (W) x 260 (D) x 270 (H) mm
Weight:	8 kg
Interface:	1 x USB
Power Supply:	100 - 240V, 50-60 Hz ≤= 600W



THERMAL CYCLER TC-TE

Code	Description
BOE 8089602	Thermal cycler TC-TE, 100-240 V, 50/60 Hz with gradient sample block for 96 x 0,2 ml

HEATING MANTLES

- » for operating temperatures up to 450°C
- » for glass flasks, round bottom up to 20 l.
- » flexible glass yarn heating element
- » plastic coated metal housing
- » thermally insulated and grounded
- » predrilled threaded hole on rear allows connection of the clamp KM-SK (accessory)

BOECO LabHEAT® KM-M SERIES

1,5 m power supply (earthed) cable with heating-zone switch



KM-M

Volume ml/l	Flask ø mm	Power W	Heating zones	Order No. 220 V AC	Order No. 110 V AC
50	51	55	1	BOE 91000050	BOE 91500050
100	64	100	1	BOE 91000100	BOE 91500100
250	85	150	2	BOE 91000250	BOE 91500250
500	105	200	2	BOE 91000500	BOE 91500500
1	131	300	2	BOE 91001000	BOE 91501000
2	166	500	2	BOE 91002000	BOE 91502000
3	185	600	2	BOE 91003000	BOE 91503000
4	207	750	2	BOE 91004000	BOE 91504000
5	223	860	2	BOE 91005000	BOE 91505000
6	236	1000	2	BOE 91006000	BOE 91506000
10	279	1400	2	BOE 91010000	BOE 91510000
20	345	2000	2	BOE 91020000	BOE 91520000

BOECO LabHEAT® KM-ME SERIES

designed identical to series KM-M, but in addition equipped with a built-in heating-zone switch and a power controller which allows a continuous adjustment of the heater power.



KM-ME

Volume ml/l	Flask ø mm	Power W	Heating zones	Order No. 220 V AC	Order No. 110 V AC
50	51	55	1	BOE 92000050	BOE 92500050
100	64	100	1	BOE 92000100	BOE 92500100
250	85	150	2	BOE 92000250	BOE 92500250
500	105	200	2	BOE 92000500	BOE 92500500
1	131	300	2	BOE 92001000	BOE 92501000
2	166	500	2	BOE 92002000	BOE 92502000
3	185	600	2	BOE 92003000	BOE 92503000
4	207	750	2	BOE 92004000	BOE 92504000
5	223	860	2	BOE 92005000	BOE 92505000
6	236	1000	2	BOE 92006000	BOE 92506000
10	279	1400	2	BOE 92010000	BOE 92510000
20	345	2000	2	BOE 92020000	BOE 92520000

BOECO LabHEAT® KM-MER SERIES

designed identical to series KM-ME, but in addition equipped with a built-in separate switched magnetic stirrer with an infinitely variable speed range - up to 1600 rpm.



KM-MER

Volume ml/l	Flask ø mm	Power W	Heating zones	Order No. 220 V AC
100	64	100	1	BOE 94000100
250	85	150	2	BOE 94000250
500	105	200	2	BOE 94000500
1	131	300	2	BOE 94001000



Code	Description
BOE 970000001	Support clamp KM-SK for the attachment of the metal-cased heating mantles to support rod or within support wall.

BOECO ASPIRATOR WITH TRAP FLASK MODEL FTA-1

is designed for aspiration/removal of alcohol/buffer remaining quantities from microtest tube walls during DNA/RNA purification and other macromolecule reprecipitation techniques.

The FTA-1 can also be used for routine operations of cell washing from culture medium and resuspension in buffer.

A suction microbiological filter eliminates the risk of contamination from the trap flask with bacteria, viruses and infected particles.

Specification:

Operating Principle: Creating negative pressure in trapping flask using built-in microprocessor

Vacuum -500mbar

Trap Flask vol.: 1000 ml

Dimension: 160 x 210 x 340 mm
(with trap flask)

Power: External power supply DC 12 V, 125 A

Net Weight: 1,9 kg

Code	Description
BOE 8039000	Aspirator with trap flask, model FTA-1
BOE 8039001	Optional 8-channel adapter manifold MA-8

MA-8
ADAPTER



SUCTION HYDRO-
PHOBIC
MICROBIOLOGIC
FILTER



ROTARY EVAPORATOR



RVO 400 SD VERTICAL CONDENSER



RVO 400 SD DIAGONAL CONDENSER



SAFETY
BATH COVER



COR 400

BOECO ROTARY EVAPORATOR RVO 400 SD

- » With digital display and control
- » Water or oil bath
- » Motorized lift
- » Built in vacuum controller
- » function of pressure and temperature gradient
- » Variable inclination angle of evaporating flask
- » With vertical or diagonal condenser
- » fitted and designed for control and communication by PC

Technical details:

Receiving flasks:	100 - 2000 ml
Evaporating flasks:	20 - 4000 ml
Rotation speed:	0 - 280 rpm
Bath temperature:	max. 100°C for water filling max. 180°C for oil filling
Regulation accuracy:	± 1°C up to 100°C ± 3°C up to 180°C
Pressure measurement:	absolute
Pressure difference:	adjustable 1-500 mbar.
Digital settings:	Temperature, rotations, vacuum
Gradient settings:	Temperature, pressure
Temperature unit selection:	°C, °K
Pressure units selections:	hPa, Torr
Cooler condensation size:	1200 sq cm (double spiral)
Switched vacuum pump:	output max 650 VA, input max. 2000 VA
Power supply:	230 V ±10%, 50/60 Hz
Power input:	max. 2000 W (excluding vacuum pump)
Dimensions in mm (WxHxD):	650 x 900 x 360 (incl. glass)
Net weight:	approx 20 kg

The RVO 400 SD conforms to the CE mark and all relevant EC standards and DIN norms and has been manufactured under ISO 9001:2000

Code	Description
BOE 8090020	BOECO Rotary Evaporator RVO 400 SD, with heating bath, motorized lift, built-in vacuum controller, digital measuring and control system with vertical condenser, 230 V
BOE 8090021	Idem for 110 V
BOE 8090030	BOECO Rotary Evaporator RVO 400 SD, with heating bath, motorized lift, built-in vacuum controller, digital measuring and control system with diagonal condenser, 230 V
BOE 8090031	Idem for 110 V

Accessories:

BOE 8090005	Safety bath cover, Plexiglass
BOE 8090006	Wireless remote controller
BOE 8090007	PC-based evaporation control software

BOECO CIRCULATION CHILLER COR 400

Performance:	1/4 HP
Performance 22°C =>7°C:	80 l/hour
Minimum temperature:	1°C for water
Minimum temperature:	-20°C for antifreezing mix
Regulation accuracy:	±1°C
Volume of cooling tank:	20 l
Displacement pump:	7 m
Pump flow:	120 l/hour
Cooling gas:	R - 134a
Power supply:	230V, 50/60Hz
Power:	max. 391 VA
Weight:	29 kg
Dimensions (w x d x h):	530 x 330 x 474 mm

Code	Description
BOE 8090010	BOECO Circulation Chiller, COR 400, 230 V, 50/60 Hz

CHEMICAL RESISTANT VACUUM PUMP

- » 100 % oil-free transfer
- » Pure transfer, evacuation and compression
- » TFM™ PTFE pump head combined with PTFE-coated diaphragm are ideal for extremely aggressive/corrosive gases and vapors.
- » ATEX-compliant in accordance with ATEX II 2G IIB+H2 T3X internal atmosphere only
- » Maintenance-free
- » Gas tight, leakage rate approx. 6×10^{-3} mbar x l/s

Specification:

Delivery:	20 l/min
Vacuum:	8 mbar abs.
Operating pressure:	0,1 bar
Connectors for tube:	ID 10 mm
Permissible media and ambient temp:	+5...+40°C
Weight / Dimensions WxHxD:	9,3 kg / 154 x 207 x 312 mm



Code	Description
KNF 309577/026366	KNF LABOPORT® Diaphragm Vacuum Pump N 820.3FT.18, 220 V, 50 Hz Pump head: TFM™ PTFE, Diaphragm: PTFE-coated, Valves: FFPM
KNF 309577/029163	Idem, 220 V, 60 Hz
KNF 309577/027170	Idem, 115 V, 60 Hz

The above pumps are suitable for our Rotary Evaporator RVO 400 SD

BOECO VACUUM PUMPS R-300, R-400

are piston-powered, oil-free vacuum pumps, adaptable to many laboratory requirements.

- » quiet and low vibration
- » Compact and light weight
- » Oil free and Maintenance-free

Specification:	R-300	R-400
Max. vacuum:	670 mm Hg	670 mm Hg
	50 Hz 60 Hz	50 Hz 60 Hz
Max flow rate:	17 l/min 20 l/min	34 l/min 37 l/min
Horse power:	1/8 HP	1/6 HP
Pole:	4 P	
Net weight:	3,5 kg	4,8 kg
Port thread:	5/16 inch (8 mm)	
Noise level:	50 db	



R-300



R-400

Code	Description
BOE 8830000	BOECO R-300 vacuum pump 220-240 V, 50/60 Hz
BOE 8830100	BOECO R-300 vacuum pump 110-120 V, 60 Hz
BOE 8840000	BOECO R-400 vacuum pump 220-240 V, 50/60 Hz
BOE 8840100	BOECO R-400 vacuum pump 110-120 V, 60 Hz

BOECO VACUUM / PRESSURE PUMP R-430

Specification:	R-430
Max. vacuum:	630 mm Hg
Max. pressure:	80 psi
	50 Hz 60 Hz
Max flow rate:	28 l/min 34 l/min
Motor rotation:	1450 rpm 1700 rpm
Horse power:	1/6 HP
Pole:	4 P
Net weight:	5,8 kg
Port thread:	5/16 inch (8 mm)
Noise level:	52,0 db



R-430

Code	Description
BOE 8843000	BOECO R-430 vacuum pump 220-240 V, 50/60 Hz
BOE 8843100	BOECO R-430 vacuum pump 110-120 V, 60 Hz



FILTRATION UNIT
BOE 8833001

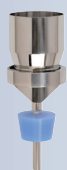

ST. STEEL
FUNNEL
BOE 16710310



MF 3



MF 3A



MV 3



MV 6



ADAPTER BOE 19010071
to enable the use of the Magnetic filter
holders MF3 instead of the st. steel fun-
nels at the above manifolds.

Filtration Accessories

Code	Description
BOE 88330001	Filtration unit for 47-50 mm membrane filter with vacuum-resistant flask, capacity 1 litre
BOE 88300002	Glass filtration set for 47 mm membrane filter with 1 litre lab storage bottle
BOE 16710310	Stainless Steel funnel, 100 ml, 47 mm Diam.

MAGNETIC FILTER HOLDERS

our MF series magnetic filter holders are designed with double-layer magnets to ensure a tight seal between the funnel and support base. The innovative design of a hose fitting detachable to the support base can allow a direct connection to the vacuum source and a flexible use with various kinds of vacuum flasks and bottles. Constructed of Polyether sulfone (PES) material, the MF series filter holders are resistant to a wide range of chemicals and high temperature. They are sturdy and autoclavable.

Specification:	MF 3	MF 3a
Funnel Capacity:		300 ml
Effective filtration area:		13,1 cm ³
Effective Diameter:		47 cm
Filter size:		47 cm
Fitting Size (tubing):		Ø 4-8 mm
Graduation increment:		50 ml
Dimensions: (Ø x H)	9 x 17 cm	9 x 10,4 cm
Net Weight:	0,3 kg	0,3 kg
Material	Polyether sulfone (PES)	
	Funnel body, Funnel base, Hose fitting, Support screen	
Silicone rubber:	Sealing gasket, Sealing plug	
Lid kit:	PP (Polypropylene construction with PTFE syringe filter)	

Code	Description
BOE 20300010	Magnetic Filter Holder 300ml MF3 with lid, long stem and silicone stopper
BOE 20310010	Magnetic Filter Holder 300ml MF3a with lid, short stem for direct application on general flask or lab bottles)

STAINLESS STEEL MANIFOLDS

Applicable for microbiology test filtration in food, pharmaceutical, beverage industries. Medium purification in life science labs. General filtration for aqueous samples. Suspended solid test filtration for municipal surface ground and drinking water

Specification:	MV 3	MV 6
Number of branches:	3	6
Effective filtration area:	47 mm / 50 mm	
Port thread:	8 mm (5/16 inch)	
Dimensions: (h x w x d)	48x13x16cm	85x13x16cm
Material	Stainless steel (SS316)	
	Pipe - Control valve - Vent valve	
	Hose barb	
Aluminium:	Handles - Knob of control valve	
FKM:	Seals of control valve - Vent valve - Hose barb	

Code	Description
BOE 18030061	3-branch stainless steel (SS316) manifold MV 3 with 3 x stainless steel funnels 100 ml
BOE 18060061	6-branch stainless steel (SS316) manifold MV 6 with 6 x stainless steel funnels 100 ml
Optional	
BOE 16710311	Stainless steel cover for 100 ml stainless steel funnel
BOE 19010071	Adapter for silicone stoppers No.8, for use with MF3

MINI DIAPHRAGM VACUUM PUMP N96

the N 96 combines a high flow rate with a compact design, saving valuable space in the laboratory. Thanks to the manual rotational speed control, the N 96 is quiet, very energy efficient, and can be optimally adjusted in accordance with the application.

Potential applications include filtration, SPE, and liquid aspiration using a vacuum.

- » 100 % oil-free transfer - thereby pure transferring evacuation and compression of gases
- » Extremely low footprint
- » Maintenance-free
- » Environmentally friendly
- » PTFE-coated diaphragm for use with aggressive/corrosive gases and vapors

Specification N 96

Flow rate:	7 l/min
Vacuum:	130 mbar abs.
Pressure:	2,5 bar
Connectors for tube:	ID 4 mm
Permissible gas and ambient temp:	+5...+40°C
Motor protection:	IP 40
Weight:	1,3 kg
Dimensions WxHxD:	156 x 119 x 75 mm



N 96

Code	Description
KNF 322806/00000	KNF LABOPORT® Diaphragm Vacuum Pump N 96, 100-240 V, 50/60 Hz, Pump head: PPS, Diaphragm: PTFE-coated, Valves: FKM

Options:

KNF 132254/000000	Fine control valve (vacuum side)
KNF 058970	Fine control valve (pressure side)

BOECO COLONY COUNTER CC-1

is suitable for counting bacteria growing on agar contained Petri dishes.

Built-in electronic register, operated by any pen. Every time a count is registered the beeper gives an audible signal to verify entry.

The pressure sensor system provides uniform sensitivity over the whole of working field.

A reset button provides immediate zeroing of the 4-digit counter

Flexible adjuster accepts 10 cm to 15 cm petri dishes

The adjustable focusing arm allows the 1,5x magnifying glass to be placed at various angles of working position.

The background plate can be changed to white or black for easy counting.

Ring-shaped lamp provides uniform working field illumination.

The number of counts is capable of being registered to maximum of 4-digits i.e. 9999 and displayed on bright red LED.

Specification:

Working Principle:	Pressure sensor system provides uniform sensitivity over the whole working field
Readout:	4-digit bright red, 0,6" LED display
Modes of Counting:	Marking pen counting (any pen)
Dimension:	30 x 33 x 10 cm (W x D x H)
Power:	115 / 230 VAC, 50/60 Hz
Net Weight:	5,2 kg

Code	Description
BOE 5157000	Colony Counter CC-1, with 1,5x standard lens, adjustable focusing arm, power cord

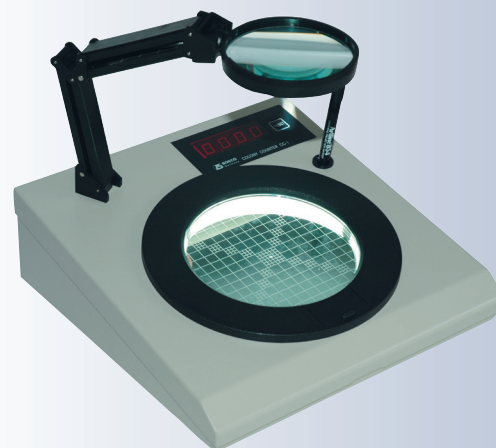

CC-1

WATER PURIFICATION

LABORATORY WATER PURIFICATION SYSTEM BOECOpure PLUS

The all-rounder for H₂O pure type ASTM I + ASTM II

If both, pure and ultra pure water in small quantities is required, BOECOpure PLUS is the perfect system.

The ability to provide both types from a single system results from the combination of ultramodern purification technologies. These also make it possible to connect the system directly to a drinking water tap.

A press on the dispenser button activates dispensing of ultrapure water type ASTM I via the digital dispenser control. The recirculation of the pure water held in the installed 10 litre tank keeps it permanently at type ASTM II quality.

Features:

- » OptiFill dispenser is standard
- » TapWater set for direct connection to a drinking water tap
- » 10-litre pure water tank has a pressure outlet
- » Tank volume display in percent
- » Simple and economical filter replacement
- » Leakage sensor is standard
- » Type ASTM I dispensing performance is 1,6 / 2 l/min.
- » Type ASTM II draw-off is up to 6 l/h / 12 l/h
- » Ready-to use, including filter cartridges
(Pre-treatment cartridge with RO membrane and ultrapure water cartridge)



BOECOpure PLUS

The BOECOpure PLUS UV is supplemented with UV-oxidation, 185/254 nm. The BOECOpure PLUS UV/UF is supplemented with an ultrafilter and UV-oxidation, 185/254 nm.

ASTM Type I Ultrapure water applicable for

Molecular biology, microbiology, PCR, inorganic and organic trace analysis
HPLC, ICP, TOC-analysis

ASTM Type II pure water applicable for

Rinsing laboratory glassware, preparing and diluting buffers, reagents,
tissue culture media and dyes.

Sample preparation for analytical methods such as flame AAS



OPTIFILL DISPENSER

BOECOpure PLUS UV/UF Flow chart

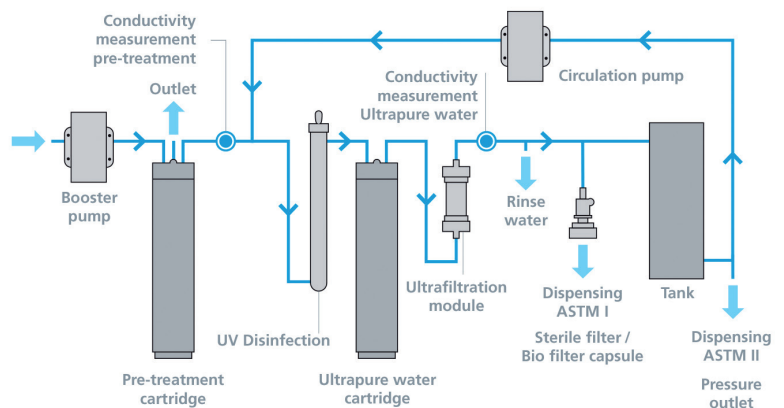

Specification BOECOpure PLUS:	Standard	UV	UV/UF
ASTM II			
Pure water performance at 15°C:	6 l/h	6 or 12 l/h	6 l/h
Conductivity:		0.067-0.1 µS/cm	
Resistance:		15-10 MΩ x cm	
Pure water tank pressurized outlet		yes	
ASTM I			
Conductivity:		0.055 µS/cm	
Resistance:		18.2 MΩ x cm	
TOC Value*:	5-10 ppb	1-5 ppb	1-5 ppb
Dispensing performance:	up to 2 l/min	up to 2 l/min	up to 1.6 l/min
Bacterial ** content:		< 1 CFU/ml	
Particles ** content:		< 1 ml	
Endotoxines*			0.001 EU/ml
Feedwater requirements			
Drinking water acc. to DIN 2000			
Feedwater temperature:		+ 2°C up to + 35°C	
Manganese and iron content:		< 0,05 mg/l	
Free chlorine content:		< 1 mg/l	
Silt density index (SDI):		max. 3	
Technical data			
Operating pressure in bar, min./max.		0,5-6 bar	
Supply voltage:		100-240 V / 50-60 Hz	
Connected load:		0.1 kW	
Connector size:		8 mm hose	
Ambient temperature:		+ 2°C up to + 35°C	
Dimensions ***, W x D x H:		390 x 725 x 615 mm	
Weight:		20/21 kg	

*in dependence on the feedwater quality **with sterilizing filter 0,2 µm ***with OptiFill Dispenser

Code	Description
BOE 8210051	BOECOpure PLUS Standard, 6 l/h Typical application: AAS, IC, ICP, buffers and media preparation
BOE 8210052	BOECOpure PLUS UV, 6 l/h
BOE 8210102	BOECOpure PLUS UV, 12 l/h Typical application: Ultra-trace analysis, ICP-MS, HPLC, TOC
BOE 8210053	BOECOpure PLUS UV/UF, 6 l/h Typical application: Life science and microbiology, cell culture media

Accessories / Consumables

Code	Description
BOE 8210005	Pre-treatment cartridge with RO-membrane, 6 l/h
BOE 8210010	Pre-treatment cartridge with RO-membrane, 12 l/h
BOE 8010003	Ultrapure water cartridge
BOE 19111300	Sterile filter capsule 0,2 µm
BOE 8510400	Sterile tank ventilation filter
BOE 8110200	Replacement UV-lamp
BOE 8010051	Replacement Ultrafilter
BOE 8210300	Wall-mount
BOE 16500030	Storage tank, 30 liter, with sterile overflow, sterile vent filter and pressure pump

Optional

The Pre-treatment pack for BOECOpure PLUS protects the reverse osmosis module against particulates, dirt, and colloids. For the complete pack the filter housing and prefilter have to be ordered.

Code	Description
BOE 16531110	Filter housing 10" without Pre-filter
BOE 16511100	Pre-filter insert 1 µm, 10"





LABORATORY WATER PURIFICATION SYSTEM

BOECOpure PLUS standard xs basic

BOECOpure PLUS UV xs basic

The simple solution for H₂O pure type ASTM I + ASTM II

The BOECOpure PLUS standard xs is an extremely compact system and the best choice when small volumes of both pure water and ultrapure water are required. It offers great flexibility and can be directly connected to the drinking water supply.

The standard OptiFill dispenser is a flexible extraction solution for a kind of laboratory vessels. The ergonomic shape of it enables onehanded use of it for both system operation and the monitoring of all quality parameters.

The dispensing of pure water and ultrapure water from a single system is made possible by the need-filling combination of ultra-modern purification technologies.

Features:

- » Reliable ASTM I + II water quality supply
- » Tap water set for direct drinking water connection
- » Optifill dispenser as standard:
 - » enables one handed dispenser operation
 - » is detachable and ergonomically shaped
 - » can be turned by 170 degrees/80 cm in diameter and is height adjustable
- » Simple and economical filter replacement
- » Clear view of controls with graphics display
- » Leak detector is included as a standard
- » Supply including all mandatory filters and consumables for start-up and operation)

The BOECOpure PLUS UV is supplemented with UV-oxidation, 185/254 nm.



OPTIFILL DISPENSER

ASTM Type I Ultrapure water applicable for

Molecular biology, microbiology, PCR, inorganic and organic trace analysis
HPLC, ICP, TOC-analysis

ASTM Type II pure water applicable for

Rinsing laboratory glassware, preparing and diluting buffers, reagents, tissue culture media and dyes.

Sample preparation for analytical methods such as flame AAS

BOECOpure PLUS UV/UF Flow chart

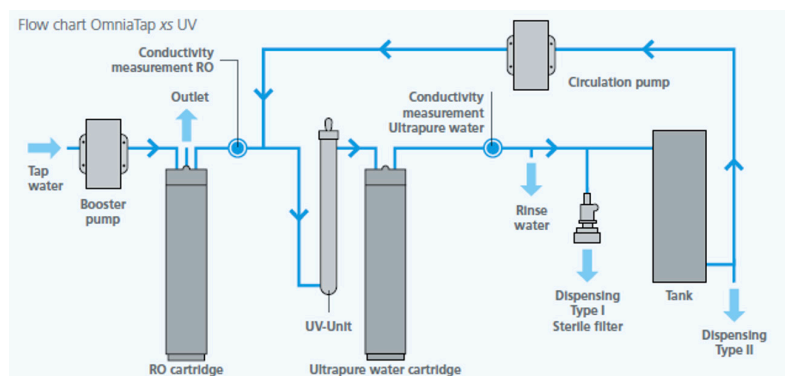

Specification BOECOpure PLUS:	Standard xs ^{basic}	UV xs ^{basic}	xs ^{touch} UV-TOC/UF
ASTM II			
Pure water performance at 15°C (l/h):	5	5	8
Conductivity at 25°C (µS/cm):	0.067-0.1	0.067-0.1	0.067-0.1
Resistance at 25°C (MΩ x cm):	15 up to 10	15 up to 10	15 up to 10
ASTM I			
Conductivity at 25°C (µS/cm):	0.055	0.055	0.055
Resistance at 25°C (MΩ x cm):	18.2	18.2	18.2
TOC Value* (ppb):	< 10	< 5	< 5
Dispensing performance (l/min.):	up to 2	up to 2	up to 2
Bacterial ** content (KBE/ml):	< 0,01	< 0,01	< 0,01
Particles ** content < 0.2 µ (1/ml):	< 1ml	< 1	< 1
Pyrogens (Endotoxins) *** (EU/ml):	-	-	< 0.001
RNase *** (pg/ml)	-	-	< 1
DNase *** (pg/m)	-	-	< 5
Proteases *** (µg/m)	-	-	< 0.15

*in dependence on the feedwater quality and regular disinfection

**with sterilizing filter 0,2 µm (Capsule BOE 19100300 or Bio filter capsule BOE 19102100)

*** With ultrafilter/bio filter capsule

Feedwater requirements

Drinking water acc. to DIN 2000

Feedwater temperature (°C):	+ 2 up to + 35	+ 2 up to + 35	+ 2 up to + 35
Feedwater pressure (bar):	0,5 up to 6	< 0,5 up to 6	0,5 up to 6 bar
Conductivity at 25°C (µS/cm):	< 2000	< 2000	< 2000
Colloid index SDI:	< 10	< 10	< 10
Free chlorine (ppm):	< 3	< 3	< 3
TOC-Value (ppm):	< 1	< 1	< 1
Hardness [as CaCo3]*:	< 300	< 300	< 300
pH range:	4 up to 10	4 up to 10	4 up to 10

* For higher values, pre-treatment must be carried out upstream

Technical data

Electrical connection (Volt/Hz):	90-240 / 50-60	90-240 / 50-60	90-240 / 50-60
Total connected load (W):	120	120	120 W
Port size - tap water:	R ¾ - female	R ¾ - female	R ¾ - female
Ambient temperature (°C):	+ 2 up to + 35	+ 2 up to + 35	+ 2 up to + 35
Dimensions, (W x D x H mm):	253 x 530 x 520	253 x 530 x 520	253 x 530 x 520*
Weight dry (kg):	19	19	19

*with OptiFill^{touch} dispenser

Code	Description
BOE 8211051	BOECOpure PLUS Standard xs basic Typical application: AAS, IC, ICP, buffers and media preparation
BOE 8211052	BOECOpure PLUS UV xs basic Typical application: Ultra-trace analysis, ICP-MS, HPLC, TOC

Accessories / Consumables

Code	Description
BOE 19200007	RO cartridge xs 5 l/h
BOE 19200103	Ultrapure water cartridge xs 055
BOE 19100300	Sterile filter capsule 0,2 µm
BOE 19111300	Sterile filter capsule 0,2 µm
BOE 19102100	Bio filter capsule
BOE 19200305	Wall mounting BOECOpure PLUS xs
BOE 19200091	Disinfection unit BOECOpure PLUS xs
BOE 19200057	Disinfectant BOECOpure PLUS

Optional

The Pre-treatment pack for BOECOpure PLUS protects the reverse osmosis module against particulates, dirt, and colloids. For the complete pack the filter housing and prefilter have to be ordered.

Code	Description
BOE 16531110	Filter housing 10" without Pre-filter
BOE 16511100	Pre-filter insert 1 µm, 10"



LABORATORY WATER PURIFICATION SYSTEM BOECOpure PLUS xs^{touch} UV-TOC/UF

The all-rounder for H₂O pure type ASTM I + ASTM II

The BOECOpure PLUS xs^{touch} is an extremely compact system to produce ultrapure water fulfilling highest demands of analytical and life sciences laboratories and can be directly connected to the drinking water supply.

Scroll and swipe to the next function with the intuitive Optifill^{touch} display and integrated monitoring unit. Adjustable limit values for conductivity and TOC, as well as data output via USB increase process reliability under consideration of highest sustainability.

Save valuable space in your lab. Configure and place the production unit under the bench and position your Optifill^{touch} dispenser and monitoring unit practical on a bench or space-saving on a wall.

Retractable and pivotable with a flexible connection for the most comfortable supply of ultrapure water to any vessel.

Features:

- » Reliable ASTM I + II water quality supply
- » Optifill^{touch} dispenser as standard:
 - » enables one handed dispenser operation
 - » Colour-touch-display with intuitive menu navigation
 - » is detachable and ergonomically shaped
 - » can be turned by 170 degrees/80 cm in diameter and is height adjustable
- » Simple and economical filter replacement
- » Real time TOC monitoring
- » Residual cartridge volume display
- » USB-Port for data in- and output
- » Leak detector is included as a standard
- » Supply including all mandatory filters and consumables for start-up and operation

The BOECOpure PLUS xs^{touch} UV-TOC/UF is supplemented with UV-oxidation, 185/254 nm.

ASTM Type I Ultrapure water applicable for

Life science and microbiology and cell culture media

ASTM Type II pure water applicable for

Rinsing laboratory glassware, preparing and diluting buffers, reagents, tissue culture media and dyes.

Sample preparation for analytical methods such as flame AAS



OPTIFILL^{TOUCH}
DISPENSER

BOECOpure PLUS UV/UF Flow chart

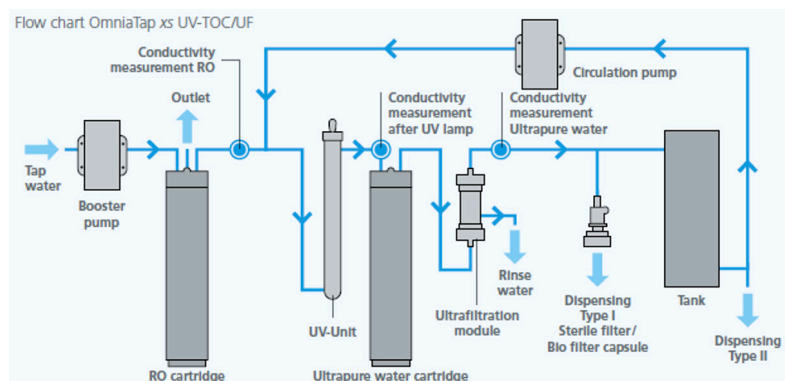

Specification BOECOpure PLUS:**xs^{touch} UV-TOC/UF****ASTM II**

Pure water performance at 15°C (l/h):	8
Conductivity at 25°C (µS/cm):	0.067-0.1
Resistance at 25°C (MΩ x cm)::	15 up to 10

ASTM I

Conductivity at 25°C (µS/cm):	0.055
Resistance at 25°C (MΩ x cm):	18.2
TOC Value* (ppb):	< 5
Dispensing performance (l/min):	up to 2
Bacterial ** content (KBE/ml):	< 0,01
Particles ** content < 0.2 µ (1/ml):	< 1
Pyrogens (Endotoxins) *** (EU/ml):	< 0.001
RNase *** (pg/ml)	< 1
DNase *** (pg/ml)	< 5
Proteases *** (µg/ml)	< 0.15

*in dependence on the feedwater quality and regular disinfection

**with sterilizing filter 0,2 µm (Capsule BOE 19100300 or Bio filter capsule BOE 19102100)

***with ultrafilter/bio filter capsule

Feedwater requirements

Drinking water acc. to DIN 2000

Feedwater temperature (°C):	+ 2 up to + 35
Feedwater pressure (bar):	0.5 up to 6
Conductivity at 25°C (µS/cm):	< 2000
Colloid index SDI:	< 10
Free chlorine (ppm):	< 3
TOC-Value (ppm):	< 1
Hardness [as CaCo3]*:	< 300
pH range:	4 up to 10

* For higher values, pre-treatment must be carried out upstream

Technical data

Electrical connection (Volt/Hz):	90-240 / 50-60
Total connected load (W):	120
Port size - tap water:	R ¾ - female
Ambient temperature (°C):	+ 2 up to + 35
Dimensions* (W x D x H mm):	253 x 530 x 520
Weight dry (kg):	19

*with OptiFill^{touch} dispenser

Code	Description
BOE 8211085	BOECOpure PLUS xs ^{touch} UV-TOC/UF Typical application: Life science and microbiology, cell culture media

Accessories / Consumables

Code	Description
BOE 19200008	RO cartridge BOECOpure Plus ^{XS}
BOE 19200103	Ultrapure water cartridge BOECOpure Plus ^{XS} 055
BOE 19100300	Sterile filter capsule 0,2 µm
BOE 19102100	Bio filter capsule
BOE 19200305	Wall mounting BOECOpure PLUS ^{XS}
BOE 19200091	Disinfection unit BOECOpure PLUS ^{XS}
BOE 19200057	Disinfectant BOECOpure PLUS

Optional

The Pre-treatment pack for BOECOpure PLUS protects the reverse osmosis module against particulates, dirt, and colloids. For the complete pack the filter housing and prefilter have to be ordered.

Code	Description
BOE 16531110	Filter housing 10" without Pre-filter
BOE 16511100	Pre-filter insert 1 µm, 10"



WATER STILLS

DEST 4



DEST-4

standard water stiller with integrated low-water cut-off, continuous production of high pure water, free of dissolved metals and pyrogens

Specification:

Distillate flow rate	approx. 4 l/h
Conductivity of distilled water (20°C)	1 µS/cm
Wattage:	2.800 W
Heater element:	Silica heater
Material of glass parts:	Borosilicate glass 3.3
Water consumption:	approx. 60 l/h
Size:	550 x 150 x 500 mm
Weight:	6,2 kg

Code	Description
BOE 8704000	DEST-4, 230 V

DEST 4L



BOECO DEST 4L

Vertical water still with stainless steel boiler and borosilicate condenser. Integrated low-water cut-off, water inlet & flow regulator, continuous production of high purity distilled water, free of metal ions, salts, dissolved gases and pyrogenic substances. With flow regulator to avoid excessive water consumption.

Specification:

Distillate flow rate:	approx 4 l/h
Conductivity of distilled water (20°C)	1,5 µS/cm
Heater:	2.800 W
Heater element:	Stainless steel (AISI 304)
Material of glass parts:	Borosilicate glass 3.3
Safety:	Low water cut-off & level switch
Water consumption:	approx. 55 l/h
Size:	690 x 280 x 280 mm
Weight:	13,7 kg

Code	Description
BOE 8704200	DEST 4L, 230 V

DEST 10L



BOECO DEST 10L

Vertical water still with 3 metallic heaters and a large surface condenser made of borosilicate glass 3.3. Designed for fully automatic operation, with an output of 10 liters per hour, includes safety features in case of lack of electricity supply or flow water supply. Automatic operation because of an included reservoir level control. If the distilled water is supplied to an external reservoir or flask the level control will unplug the water still DEST 10L if the reservoir is full and start again if the water level has been reduced in the reservoir.

Specification:

Distillate flow rate:	approx. 10 l/h
Conductivity of distilled water (20°C):	1,5 µS/cm
Heater:	3 x 2.200 W
Heater element:	Stainless steel (AISI 304)
Material of glass parts:	Borosilicate glass 3.3
Safety:	Low water cut-off & level switch
Water consumption:	approx. 1,5 l/min
Size:	360 x 400 x 960 mm
Weight:	approx. 16 kg

Code	Description
BOE 8711811	DEST 10L, 230 V, single phase
BOE 8711812	DEST 10L, 380 V, 3-phase

BOECO WS 4000 / WS 8000

Stainless steel water still with thermostatic low water cut-off and level switch which activates the heater if there is enough level of water in the boiler.

Specification:	WS 4000	WS 8000
Distillate flow rate:	approx. 4 l/h	approx. 7,5-8 l/h
Cond. of dist water (20°C):	approx. 1,5 µS/cm	
Heater:	3 KW	6 KW
Cooling water:	approx. 60 l/h	approx. 84 l/h
Material: Inner part:	Stainless steel	
Outer part:	Stainless steel & powder coating	
Size: (h x w x d)	435x370x220mm	635x370x260 mm
Switch:	Main power with pilot lamp	
Sealing:	Silicone gasket	
Safety:	Low water level & over heating cut-off	
Weight:	8,6 kg	12,2 kg



BOECO WS 4000 / WS 8000

Code	Description
BOE 8703600	WS 4000, 230 V
BOE 8703601	WS 4000, 110 V
BOE 8707500	WS 8000, 230 V

BOECO DEST TANK 4000 / 8000

Stainless steel water still for automatic and continuous operation with built-in 8/16 l storage tank. For bench and wall mounting. Supplied with wall mounting bracket. Excellent quality of distillation. An electronic level switch switches the still off when the storage tank is full and restarts it automatically when distilled water is withdrawn. Dispenser Tap of distilled water. With flow regulator to avoid excessive water consumption.

Specification:	DEST TANK 4000	DEST TANK 8000
Distillate flow rate:	approx. 4 l/h	approx. 8 l/h
Water tank capacity:	8 l	16 l
Cond. of dist water (20°C):	approx 1,5 µS/cm	
Power:	3.000 W	6.000 W
Cooling water:	approx. 55 l/h	approx. 80 l/h
Material: Inner part:	Stainless steel	
Outer part:	Galvanized steel & powder coating	
Switch:	Main power with pilot lamp	
Safety:	Low water level & over heating cut-off	
Size (wxdxh):	620x330x460 mm	720x350x700 mm
Weight:	24,6 kg	36,0 kg



BOECO DEST TANK 4000 / 8000

Code	Description
BOE 8704500	DEST TANK 4000, 230 V
BOE 8704501	DEST TANK 4000, 115 V
BOE 8708000	DEST TANK 8000, 230 V



DS 450

PRESSURELESS DEIONIZER DS 450, DS 750

pressureless ion exchanger in disposable cartridges of synthetic material. Excellently suited for medical practices and small laboratories requiring up to 10 litres a day. Supplied with conductivity meter, wall mount and a set of hoses.

Specification:	DS 450	DS 750
Flow rate:	50 l/h	100 l/h
Capacity at 10° GSG:	425 l	750 l
Quality:	0,1 - 20 µS/cm	0,1 - 20 µS/cm
Temperature max:	30°C	30°C
Material	Polyethylene	Polyethylene
Size (h x diam.):	600 x 100 mm	470 x 125 mm
Weight:	3,1 kg	6 kg

Code	Description
BOE 11042506	Deionizer DS 450, 230 V, 50/60 Hz
BOE 11042507	Deionizer DS 450, 110 V, 60 Hz
BOE 11042706	Set of two replacement cartridges

Code	Description
BOE 11170506	Deionizer DS 750, 230 V, 50/60 Hz
BOE 11170600	Deionizer DS 750, 110 V, 60 Hz
BOE 11175010	Replacement cartridge for DS 750
BOE 20100501	2 x 5 liter resin for DS 750



BIDEST 4

BOECO BIDEST 4

is our Bidistiller designed to work automatically with a production of 4 liters per hour, includes several safety systems to work continuously.

- » Produces distilled water for the most common applications in the laboratory.
- » Boiler and Condenser are made of borosilicate glass 3.3. The heaters are sheathed with quartz glass. This is ideal for producing high quality water, free of metal ions and pyrogens, with a conductivity 1-2 µS / cm.
- » Incorporates several security systems for automatic operation: prestat, electrovalve and level sensor.
- » Cooling water outlet by rubber tube. The condensed water not flowing through the cooling water outlet.
- » Energy saving through distillation of preheated cooling water.
- » Distillation process visible through the front screen.
- » The main switch and monitor drivers are on the front of the unit.
- » Control of water level automatic cut-off power in case of lack of water.
- » Output of the distillate on the side of the unit.
- » Output of carbon dioxide through hole of the top of condensers
- » Suitable for wall mounting.

Safety systems

Prestat

Safety thermostat protects still in the event of water supply failure.

Electrovalve

It cuts water and electrical supply to avoid useless expenses of water and electricity.

It returns to open water inlet if the electrical supply is enough to let the water still to work properly.

Level device

Device to fill a container without worrying when it finished. It cuts water and electrical supply to avoid useless expenses of water and electricity.

Specification:

Output:	approx. 4 l/h
Conductivity of distilled water (20°C):	1-2 µS/cm
pH:	Depends on tap water inlet 5,5-7
Heater:	2 x 3.000 W
Heater element:	Quartz sheathed heater
Material of glass parts:	Borosilicate glass 3.3
Water consumption:	approx. 2 l/min
Size:	700 x 360 x 470 mm
Weight:	31,8 kg

Note on the water output:

Depends directly on the quality of water supply and other environmental factors, maybe type III (according to ASTM). As distillates are open to the atmosphere before measurements can be made, the value of conductivity is really much less (down to 10 times) than it is really measured. Any ultra pure water in contact with the atmosphere has a conductivity of 1-2 µS/cm and a pH of 5, due to the small amount of CO₂ (0.05 ppm) from the atmosphere.

ELECTROCHEMISTRY

BOECO PORTABLE PH/ORP/TEMP METER MODEL PT-380

- » Simultaneous displays pH or mV and temperature.
- » Convenient calibration with automatic buffer recognition of European and US buffer sets. Calibration data is stored in memory and is ready for use on power up.
- » Automatic or manual temperature compensation
- » Automatic lock mode and end point sensing are available to lock in stable readings.
- » 50 data set reviewable memory.
- » Automatic shut off function (30 minutes of non-use)
- » Battery life 1000 hours
- » Low battery indicator
- » IP65 waterproof case

The PT-380 will be delivered incl. the following standard accessories:
1 x ATC probe 6000AST, each 1 x 100 ml BOECO Buffer solution pH 4,01, pH 7,00, 1 x 9 V battery, 1 x operating manual, 1 x carrying case

Specification:

pH

Range	Resolution	Accuracy
-2 to 16,00 pH	0,01 pH	$\pm 0,01 \pm 1$ digit

mV

Range	Resolution	Accuracy
-1999 to 1999 mV	1 mV	$\pm 0,1 \%$

Temperature

Range	Resolution	Accuracy
-10,0 to 120,0 °C	0,1 °C	$\pm 0,5 \%$

pH buffer recognition:	US (4,01, 7,00, 10,01) NIST (4,00, 6,86, 9.18) user selectable
pH electrode offset Recognition:	± 90 mV at pH 7,00 or 6.86
pH electrode slope Recognition:	$\pm 30\%$ at pH 4,00, 4,01, 9,18 or 10,01
pH temp. compensation:	Auto / manual -10,0 to 120 °C
Input Impedance:	10^{12} ohms
Temperature sensor:	Thermistor, 10K ohms at 25°C
RS 232 interface:	no
Power requirement:	9 Volt battery
Dimensions (LxWxH):	198 x 70 x 37 mm
Weight:	0,26 kg (1 x 9V Battery included)

Code

Description

BOE 5190380	Portable pH/ORP/Temperature meter, model PT-380 in carrying case with standard accessories without electrode
-------------	--



BOECO PORTABLE PH/ORP/TEMP METER MODEL PT-380



BOECO ELECTRODES

The electrodes are not included with the pH meters and have to be ordered separately:

Code

Description

BOE 5190600	Basic pH combination electrode, BA ECO plastic PC shaft, gel electrolyte, 0...14 pH, 0...80°C, with BNC plug, 1m cable, glass sensor
BOE 5095695	Basic pH combination electrode BA 25, Noryl plastic shaft, gel electrolyte, 0...14 pH, -5...80°C, with BNC plug, 1m cable, fibre diaphragm
BOE 5095626	Basic pH combination electrode BA 17, glass shaft, liquid electrolyte, 0...14 pH, 0...100°C, with BNC plug, 1m cable. With leak proof refill opening, platinum diaphragm



BOECO ELECTRODES

BOECO PH/ORP/TEMP BENCH TOP METER MODEL BT-700

- » LCD display with backlight showing pH / ORP and temperature readings
- » Up to 5 point calibration for pH and one point calibration for and ORP
- » Automatic buffer recognition (NIST and USA)
- » Automatic or manual temperature compensation
- » Bluetooth function to connect to tablets
App name **BOECO E-Chem BT-700 (App Store / Googleplay)**
- » When the unit is connected to a bluetooth device, the user can store data into the device that meets GLP requirements
- » AC adaptor or battery power (low battery indicator)

The BT-700 will be delivered incl. the following standard accessories:
1 x ATC probe, each 1 x 500 ml Buffer solution pH 4,01, pH 7,00
1 x AC adaptor, 1 x operating Manual, 1 x flexible electrode holder.
6 x 1,5 V AAA batteries

Specification:

pH

Range	Resolution	Accuracy
-2 to 16,00 pH	0.01 pH	± 0,01

mV

Range	Resolution	Accuracy
-1999,9 to 1999,9 mV	0,1 mV	A 0,05 % full scale

Temperature

Range	Resolution	Accuracy
-10 to 120,0°C	0,1°C	±0,2°C

pH buffer recognition:

US (1,68, 4,01, 7,00, 10,01, 12,46) or
NIST (1,68, 4,00, 6,86, 9,18, 12,46)
user selectable

Buffer temp. range

0 - 60,0 °C

pH calibration

Up to 5 points

ORP calibration:

1 point Offset ±150mV

ATC :

Auto / manual -10,0 to 120°C

Input impedance:

>1x10¹² ohms

Connectivity:

Bluetooth

Memory:

When the unit is connected to a bluetooth device, the user can store data into the device that meets GLP requirements

Temperature sensor:

Thermistor, 10K ohms at 25°C

Power requirement:

6 x 1,5 Volt AAA Alkaline batteries or
AC adaptor

Case:

IP54 waterproof

Dimensions (LxWxH):

210 x 150 x 45 mm

Weight:

0,43 kg

Code

BOE 5196700

Description

Bench Top pH/mV/Temp Meter, Model BT-700,
AC adaptor with attachable EURO/US plug
with standard accessories, without electrode



BT-700

BOECO MULTIPARAMETER PH/ORP/CONDUCTIVITY/TDS/SALINITY/RESISTIVITY/TEMPERATURE BENCH TOP METER MODEL MBT-700

- » LCD display with backlight showing pH / ORP or Conductivity / TDS / Salinity and temperature readings
- » Two channel measurement allows measuring pH/ORP and Conductivity/TDS/ Salinity simultaneously
- » Up to 5 point calibration for pH and one point calibration for conductivity and ORP
- » Automatic or manual temperature compensation
- » Automatic buffer recognition (NIST and USA)
- » Bluetooth function to connect to tablets.

App name: BOECO E-Chem MBT-700

- » When the unit is connected to a bluetooth device, the user can store data into the device that meets GLP requirements.

The MBT-700 will be delivered incl. the following standard accessories:
 1 x ATC probe, each 1 x 500 ml Buffer solution pH 4,01, pH 7,00
 1 x AC adaptor, 1 x operating manual, 1 x flexible electrode holder, 1 x 4 wire Conductivity cell 101C

Specification:

Conductivity K = 0,475

Range	Resolution	Accuracy
0,0 to 474,9µS/cm	0,1µS/cm	±0,5% Full Scale
475 to 4749µS/cm	1µS/cm	±0,5% Full Scale
4,75 to 47,49mS/cm	0,01mS/cm	±0,5% Full Scale
47,5 to 200,0mS/cm	0,1mS/cm	±0,5% Full Scale

Conductivity K = 0,1

Range	Resolution	Accuracy
0.00 to 99,99µS/cm	0,01µS/cm	±0,5% Full Scale
100 to 200µS/mS	0,1µS/cm	±0,5% Full Scale

TDS

Range	Resolution	Accuracy
0,00mg/l to 200,0g/l	0,01/0,1/1mg/l 0.01/0,1 g/l	±0,5% Full Scale

Salinity

Range	Resolution	Accuracy
0,0 to 80,0 ppt	0,1 ppt	±0,5 % Full Scale

pH

Range	Resolution	Accuracy
-2,00 to 16,00 pH	0,01 pH	±0,01pH

mV

Range	Resolution	Accuracy
-1999,9 to 1999,9 mV	0,1 mV	±0,05% Full Scale

Temperature

Range	Resolution	Accuracy
-10,0 to 120,0°C	0,1°C	±0,2°C

pH buffer recognition:	US (1,68 4,01, 7,00, 10,01, 12,46 or NIST (1,68, 4,00, 6,86, 9,18, 12,46)
mV Offset	±150 mV
pH calibration:	
Up to 5 points	
Conductivity Calibration:	1 point in each range
ATC :	Auto / manual -10,0 to 120°C
Input impedance:	>1x10 ¹² ohms
Temperature sensor:	Thermistor, 10K ohms at 25°C
Memory:	When the unit is connected to a bluetooth device, the user can store data into the device that meets GLP requirements
pH electrode connection:	BNC
Conductivity cell connection:	8 PIN connector
Connectivity:	Bluetooth
Power requirement:	6 x 1,5 Volt AAA Alkaline batteries or AC adaptor
Case:	IP54 waterproof
Dimensions (LxWxH):	210 x 150 x 45 mm
Weight (net):	approx. 0,43 kg

Code

Description

BOE 5197700	Bench Top pH/mV/Ion/Temp Meter, Model MBT-700, AC adaptor, with standard accessories as above mentioned, without electrode
-------------	--



PH/TEMP. TESTER PT-70 WITH
REPLACEABLE ELECTRODE

ELECTRODE MODULE

PHBOECO /TEMP. POCKET TESTER PT-70

with replaceable electrode

- » Large display screen - displays pH and temperature at the same time
- » 1, 2 or 3 point calibration, with automatic buffer recognition of US and NIST buffer sets
- » Readings are automatically compensated for temperature (ATC)
- » Electrode efficiency display
- » Replaceable electrode module ensures extended usefulness
- » IP67 water-tight housing
- » Auto power off after 10 minutes of inactivity
- » Battery life over 200 hours

Specification:

Modes:		pH, °C
Ranges:	pH	0 to 14 pH
	Temp.	-9,9...99,9 °C
Resolution:	pH	0,01 pH
	Temp.	0,1 °C
Accuracy:	pH	± 0,02 pH ± 1 digit
	Temp.	± 0,3 °C ± 1 digit
Temperature compensation:		Auto from -9,9 to 99,9°C
pH buffer recognition:		US (pH 4.01, 7.00, 10.01) NIST (pH 4.00, 6.86, 9.18)
Buffer temp range:		0,0 - 60 °C
Input impedance:		> 10 ¹² ohms
pH calibration:		1, 2 or 3 point calibration
pH electrode offset recognition:		±90mV at pH 7,00 ±98,3mV to -81,7mV at pH 6,86 ±30% at pH 4,00; 4,01; 9,18 and 10,01
pH electrode slope recognition:		
Power:		4 x LR44 bottom cell batteries
Dimensions :		193 x 44 x 25 mm
Weight :		0,105 kg (incl. batteries)

Code	Description
BOE 5190070	PH/Temp. Tester PT-70
BOE 5190071	Spare pH electrode module PT-70-1 for PT-70

TECHNICAL BUFFER SOLUTIONS

In square plastic bottles, PE, 500 ml, labeled with an individual batch no. on the bottles, traceable to SRM of NIST

Code	Description
BOE 104000	pH 4,00 (20°C), 500 ml
BOE 107000	pH 7,00 (20°C), 500 ml
BOE 610000	pH 10,00 (20°C), 500 ml
BOE 104004	pH 4,00 (20°C), 500 ml, red colour coded
BOE 107006	pH 7,00 (20°C), 500 ml, green colour coded
BOE 610008	pH 10,00 (20°C), 500 ml, blue colour coded

CONDUCTIVITY CALIBRATION SOLUTIONS

In square plastic bottles, PE, 250 ml, labeled with an individual batch no. on the bottles, traceable to PTB and NIST

Code	Description
BOE 300141	1,413 mS/cm KCL 0,01 mol/l (25°C), 250 ml
BOE 301288	12,88 mS/cm KCL 0,1 mol/l (25°C), 250 ml
BOE 311180	111,8 mS/cm KCL 1 mol/l (25°C), 250 ml

ELECTROLYTE SOLUTION

In square plastic bottles, PE, 500 ml, labeled with an individual batch no. on the bottles

Code	Description
BOE 400300	Potassium chloride 3 mol/l, 500 ml



PH INDICATORS

pH-Fix is the most popular indicator stick for all purposes. The indicator dyes are chemically bound to the cellulose fibres, avoiding bleeding even in strong alkaline samples. Presentation: Box of 100 sticks 6 x 85 mm

Code	Description
M-N 92110	pH-Fix 0-14, pH Graduation 1,0

The budget priced universal indicator papers can be used for most standard applications. For each pH-value these papers show a single colour which can be matched with the colour scale at an interval of 1 pH-unit. Presentation: Reel of 5 m length and 7 mm width

Code	Description
M-N 90204	pH-Universal Indicator Paper, pH 1-14, pH Graduation 1,0/2,0



PH INDICATORS

BOECO PORTABLE DO/TEMP. METER MODEL DO-580

- » Simultaneous display of dissolved oxygen and temperature measurements
- » Automatic temperature compensated (ATC) dissolved oxygen readings
- » User selectable salinity and pressure compensated dissolved oxygen readings
- » Works with accurate and reliable galvanic dissolved oxygen probes
- » 50 data set reviewable memory
- » Automatic shut off function (30 minutes of non-use)
- » Battery life approx. 200-500 hours
- » Low battery indicator
- » IP65 waterproof case

Specification:

Dissolved Oxygen (ppm)

Ranges	0,00 to 20,00 ppm (mg/L)
Resolution	0,01 ppm (mg/L)
Accuracy	±2 % of the reading or ±0,2 ppm

Dissolved Oxygen (%)

Ranges	0,0 to 200,0 %
Resolution	0,1 %
Accuracy	±2 % of the reading or ±0,2 air saturation

Temperature

Ranges	-6 to 46,0 °C
Resolution	0,1°C
Accuracy	±0,3 °C ±1 digit

Pressure compensation: 600 to 1100 mBar (450 to 825 mmHg)

Salinity compensation: From 0,0 to 40,0 ppt

Electrode type: Galvanic

Temperature sensor: Thermistor, 10K ohms, at 25 °C

Calibration backup: Yes

Automatic temp. comp: Yes

Power: 9 Volt battery

Size (LxWxD): 198 x 70 x 37 mm

Weight: 1,26 kg (1 x 9V Battery included)

The DO-580 will be delivered incl. the following standard accessories:
1 x Watertight dissolved oxygen probe LD-900-11, 1 x 30 ml Galvanic O2 Fill Solution, 1 x 9 V battery, 1 x Operating manual, 1 x carrying case

Code	Description
BOE 5190580	Portable DO/Temperature Meter, Model DO-580 in carrying case with dissolved oxygen probe LD-900-11



BOECO PORTABLE DO/TEMP METER MODEL DO-580





BOECO PORTABLE CONDUCTIVITY/
TDS/SALINITY/TEMP METER
MODEL CT-480



BOECO PORTABLE CONDUCTIVITY/TDS SALINITY/TEMP. METER MODEL CT-480

- » Simultaneous displays of conductivity, salinity or TDS with temperature measurements.
- » Convenient one point calibration. Calibration data is stored in memory and is ready for use on power up.
- » Adjustable TDS coefficient, reference temperature and temperature coefficient
- » Uses one conductivity cell for conductivity, salinity and TDS measurement
- » Accepts 4-wire conductivity cells with $k=0,475$ cell constant and 2-wire $K=0,1$ cell constant for improved flexibility and accuracy
- » 50 data set reviewable memory
- » Automatic shut off function (30 minutes of non-use)
- » Battery life approx. 200-500 hours
- » Low battery indicator
- » IP65 waterproof case

Specification:

Conductivity $K = 0,475$

Range	Resolution	Accuracy
0,0 to 475 μ S/cm	0,1 μ S/cm	$\pm 1\%$ of reading +2 μ S/cm
475 to 4750 μ S/cm	1 μ S/cm	$\pm 1\%$ of reading +5 μ S/cm
4,75 to 47,50mS/cm	0,01mS/cm	$\pm 1\%$ of reading +0,05mS/cm
47,5 to 200,0mS/cm	0,1mS/cm	$\pm 2,5\%$ of reading +0,5mS/cm

Conductivity $K = 0,1$

Range	Resolution	Accuracy
0,00 to 99,99 μ S/cm	0,01 μ S/cm	$\pm 1\%$ of reading
100 to 200 μ S/cm	0,1 μ S/cm	$\pm 1\%$ of reading

Salinity

Range	Resolution	Accuracy
0,0 to 70,0 ppt	0,1 ppt	$\pm 0,2\%$ Full Scale

Temperature

Range	Resolution	Accuracy
-10,0 to 90,0 °C	0,1 °C	$\pm 0,2\%$ or $\pm 4\%$ Full Scale whichever is greater

Reference Temp.:	From 15,0 to 25,0°C, default is 25,0°C
Temperature Coefficient:	From 0,00 to 4,00 °C, default is 1,91°C
TDS Constant:	From 0,30 to 1,00, default is 0,65
Cell Constant:	4 wire conductivity cell: $K = 0,475$
ATC:	Thermistor, 10K ohms, at 25°C
Power :	9 Volt battery
Size (LxWxD) :	196 x 70 x 37 mm
Weight :	1,36 kg (1 x 9V Battery included)

The CT-480 will be delivered incl. the following standard accessories:
1 x 4-wire conductivity cell 3020P with $k=0,475$
1 x 9 V battery, 1 x operating manual, 1 x carrying case

Code	Description
BOE 5190480	Portable Conductivity/Salinity/TDS/Temperature Meter, Model CT-480 in carrying case with 4-wire Conductivity Cell 3020P with 6 PIN connector, $K=0,475$ (50 μ S - 200mS/cm)

Optional Conductivity Cell:

BOE 5190109	2-wire Conductivity Cell 109P with 6 PIN connector, $K=0,1$ (0,0 - 200,0 μ S/cm)
-------------	--

BOECO BENCH TOP CONDUCTIVITY/ TDS/SALINITY/TEMP. METER MODEL CT-676

- » Simultaneous displays of conductivity, salinity or TDS with temperature measurements.
- » Convenient one point calibration. Calibration data is stored in memory and is ready for use on power up.
- » Adjustable TDS coefficient, reference temperature and temperature coefficient
- » Uses one conductivity cell for conductivity, salinity and TDS measurement
- » Accepts 4-wire conductivity cells with $k=0,475$ cell constant and 2-wire $K=0,1$ cell constant for improved flexibility and accuracy
- » Low battery indicator
- » IP54 waterproof case

Specification:

Conductivity K = 0,475

Range	Resolution	Accuracy
0,0 to 475 μ S/cm	0,1 μ S/cm	$\pm 1\%$ of reading +2 μ S/cm
475 to 4750 μ S/cm	1 μ S/cm	$\pm 1\%$ of reading +5 μ S/cm
4,75 to 47,50mS/cm	0,01mS/cm	$\pm 1\%$ of reading +0,05mS/cm
47,5 to 200,0mS/cm	0,1mS/cm	$\pm 2,5\%$ of reading +0,5mS/cm

Conductivity K = 0,1

Range	Resolution	Accuracy
0,00 to 99,99 μ S/cm	0,01 μ S/cm	$\pm 1\%$ of reading
100 to 200 μ S/cm	0,1 μ S/cm	$\pm 1\%$ of reading

Salinity

Range	Resolution	Accuracy
0,0 to 70,0 ppt	0,1 ppt	$\pm 0,2\%$ Full Scale

Temperature

Range	Resolution	Accuracy
-10,0 to 90,0 $^{\circ}$ C	0,1 $^{\circ}$ C	$\pm 0,2\%$ or $\pm 4\%$ Full Scale whichever is greater

Reference Temp.:	From 15,0 to 25,0 $^{\circ}$ C, default is 25,0 $^{\circ}$ C
Temperature Coefficient:	From 0,00 to 4,00 $^{\circ}$ C, default is 1,91 $^{\circ}$ C
TDS Constant:	From 0,30 to 1,00, default is 0,65
Cell Constant	4 wire conductivity cell: $K = 0,475$
ATC	Thermistor, 10K ohms, at 25 $^{\circ}$ C
Power Requirement:	6 x 1,5 Volt AAA batteries or AC adaptor
Dimensions (LxWxH):	150 x 203 x 72 mm
Weight:	2,3 kg (6 x 1,5 V AAA Batteries included)

The CT-676 will be delivered incl. the following standard accessories:
 1 x 4-wire conductivity cell 3020P with $k=0,475$, 6 x 1,5V AAA batteries,
 1 x operating manual, 1 x flexible electrode holder

Code	Description
BOE 5196760	Bench Top Conductivity/Salinity/TDS/Temperature Meter, Model CT-676 with 4-wire Conductivity Cell 3020P with 6 PIN connector, $K=0,475$ (50 μ S - 200mS/cm), with EURO plug
BOE 5196761	Idem, with US plug AC adaptor

Optional Conductivity Cell:

BOE 5190109	2-wire Conductivity Cell 109P with 6 PIN connector, $K=0,1$ (0,0 - 200,0 μ S/cm)
-------------	--



CT-676



CENTRIFUGES



**BOECO HAEMATOCRIT
CENTRIFUGE HC-240**



Haematocrit rotor with lid as
evaluation disc included.

capacity	75 µl
Capillaries	1,5 x 75 mm
 Rotor and Lid as evaluation disc incl.	
Cat.-No.	—
capillaries per rotor	24
RCF	16,060
radius in mm	85
run-up in sec	9
run-down in sec ²	16

BOECO HAEMATOCRIT CENTRIFUGE HC-240

High-speed bench-top centrifuge for haematocrit determinations with brushless frequency drive. At 16.060 g sedimentation is completed in just a little over 6 minutes.

The HC-240 centrifuge includes a segmented haematocrit rotor for 24 capillaries. With the segmented haematocrit rotor every capillary has its own chamber. If a capillary breaks, the fragments stay in this chamber or segment without affecting other capillaries.

The lid of the rotor is evaluation disc and cover in one. The haematocrit value can be read off the lid/evaluation disc right after centrifugation.

Controls and displays

- » During centrifugation the actual values of the parameters are indicated
- » The centrifuge's speed and running time can be variably adjusted for different applications
- » Speed display in RPM or RCF
 - RPM input from 200 to 10.000 in steps of 10, starting from 10.000 to the maximum speed in steps of 100
 - RCF input from 200 to 10.000 in steps of 1, starting from 10.000 to the maximum speed in steps of 10
- » Time t/min: 1 - 99 min. in steps of 1 min.,
Time t/sec: 1 - 59 sec. in steps of 1 sec.,
Continuous operation
- » Brake stage, selectable between fast and slow
- » Pulse key: For short centrifugation operations
- » Open lid key

Safety

- » Lid locking and holding device
- » Emergency lid lock release
- » Lid closure of metal
- » Imbalance switch-off
- » Flexible motor bearings
- » Deep metal rotor chamber (die-cast-aluminium) to securely accommodate the rotor

Design

- » Smooth plastic housing, easy to clean
- » Metal lid
- » Deep metal rotor chamber

Technical details

Max. RPM (speed) / RCF:	13,000 rpm / 16,060 RCF
Noise level:	≤ 57 dB(A)
Dimensions in mm (HxWxD):	228 x 262 x 352
Net weight:	10 kg
Emission / Immunity :	EN / IEC 61326-1, class B / FCC class B

The HC-240 conforms to safety regulations such as IEC 61010, or the EC mark and all relevant EU standards and DIN norms and has been manufactured under ISO 9001:2015

Code

Description

BOE 01801-13	BOECO centrifuge HC-240, 208-240 V, 50/60 Hz, with haematocrit rotor and lid as evaluation disc
BOE 01801-12	BOECO centrifuge HC-240, 100-127 V, 50/60 Hz, with haematocrit rotor and lid as evaluation disc

BOECO CENTRIFUGE SC-8

Practical and handy the SC-8 is the ideal centrifuge for small sample volumens. It is supplied with a 8-place angle steel rotor, which accomodates various tube systems as well as 15 ml glass tubes without adapters. The centrifuge is microprocessor controlled.

Controls and displays

- » During centrifugation the actual values of the parameters are indicated
- » The centrifuge's speed and running time can be variably adjusted for different applications:
- » Speed display in RPM or RCF
 - RPM input from 200 to the maximum speed in steps of 10
 - RCF input from 200 to the maximum speed in steps of 1
- » Time t/min: 1 - 99 min. in steps of 1 min.,
Time t/sec: 1 - 59 sec. in steps of 1 sec.,
Continuous operation
- » Brake stage, selectable between fast and slow
- » Pulse key: For short centrifugation operations
- » Open lid key

Safety

- » Lid locking and holding device
- » Emergency lid lock release
- » Lid closure of metal
- » Imbalance switch-off
- » Flexible motor bearings
- » Deep metal rotor chamber (die-cast-aluminium) to securely accomodate the rotor

Design











- » Smooth plastic housing, easy to clean
- » Metal lid
- » Deep metal rotor chamber

The SC-8 conforms to safety regulations such as IEC 61010, or the EC mark and all relevant EU standards and DIN norms and has been manufactured under ISO 9001:2015

Technical details

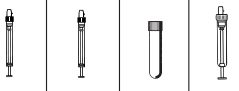
Max RPM (speed) / RCF:	6,000 rpm / 3,461 RCF
Noise level:	≤ 50 dB(A)
Dimensions in mm (HxWxD):	228 x 262 x 352
Net weight:	8,9 kg
Emission / Immunity:	EN / IEC 61326-1, class B / FCC class B

Code	Description
BOE 01800-13	BOECO centrifuge SC-8, 208-240 V, 50/60 Hz, complete with 8-place angle rotor
BOE 01800-12	BOECO centrifuge SC-8, 100-127 V, 50/60 Hz, complete with 8-place angle rotor

capacity in ml	4	5	7	15	15	blood collection / urine tubes
dimensions Ø x L mm	10 x 88	12/13 x 75	13 x 100	17 x 100	17 x 120	max 17 x 100
						
n=6,000 min ⁻¹ Rotor included						
Cat.-No.	06305	01054-A	01058	-	-	-
tubes per rotor	8	8	8	8	4	8
RCF	2,817	2,697	3,461	3,461	3,461	3,461
radius in mm	70	67	86	86	86	99
run-up in sec	17					
run-down in sec ²⁾	37					



BOECO CENTRIFUGE SC-8



BOECO CENTRIFUGE SC-6



BOECO CENTRIFUGE SC-6

The BOECO SC-6 is a small centrifuge with a swing-out rotor especially designed for use in clinical laboratories and medical practices.

It accepts common blood or urine tubes up to a volume of 15 ml and accelerates them to a maximum speed of 4,000 rpm⁻¹

The BOECO SC-6 delivers optimal separation results and a horizontal layer of the separating gel that is identical to that achieved with a large centrifuge. Samples are therefore optimally prepared for analysis.

Controls and displays

- » During centrifugation the actual values of the parameters are indicated
- » The centrifuge's speed and running time can be variably adjusted for different applications.
- » Speed display in RPM x 100, input in steps of 100
- » Time t/min: 1 - 99 min, continuous operation
- » Pulse key: For short centrifugation operations
- » Open lid key

Safety

- » Lid locking and holding device
- » Centrifuge chamber of stainless steel
- » Emergency lid lock release
- » Lid closure of metal
- » Imbalance switch-off
- » Flexible motor bearings

Design











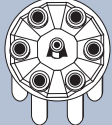





- » Smooth plastic housing, easy to clean
- » Metal lid
- » Stainless steel centrifugation chamber, deep-drawn and seamless

The SC-6 conforms to safety regulations such as IEC 61010, or the EC mark and all relevant EU standards and DIN norms and has been manufactured under ISO 9001:2015

Technical details

Max RPM (speed) / RCF:	4,000 rpm / 2,254 RCF
Noise level:	≤ 50 dB(A)
Dimensions in mm (HxWxD):	239 x 326 x 389
Net weight:	13,5 kg
Emission / Immunity:	EN / IEC 61326-1, class B / FCC class B

Code	Description
BOE 02300-13	BOECO centrifuge SC-6, 200-240 V, 50/60 Hz, complete with 6-place swing-out rotor and carriers 02331 and 02333 (6 of each)

capacity in ml	4	5	6	1,6-7	4-7	8,5-10	15	blood collection / urine tubes	
dimensions Ø x L mm	10 x 88	12x75	12x82	13/16x75	13x100	16x100	17x100	max 17 x 100	
 n=4,000 min ⁻¹ Rotor and carriers included									
									
Cat.-No.	02331	02333	02333	02333	02331	02331	02331	02331	
tubes per rotor	6	6	6	6	6	6	6	6	
RCF	2,254	1,807	1,807	1,807	2,254	2,254	2,254	2,254	
radius in mm	126	101	101	101	126	126	126	126	
run-up in sec	10								
run-down in sec ²⁾	22								

BOECO CENTRIFUGE C-28A

The non-refrigerated microprocessor-controlled C-28A is the ideal bench-top centrifuge for performing daily routine tasks in doctors' laboratories and small hospitals. But because of the wide range of accessories the C-28A can also be used for sample preparation in research and industrial laboratories.

The centrifuge has a brushless frequency drive (no carbon brushes). A special locking device allows effortless opening and closing of the lid with just one hand.

Controls and displays

- » During centrifugation the actual values of the parameters are indicated
- » Entry of the running parameters via foil keypad
- » Speed display in RPM x 100, input in steps of 100
- » Time t/min: 1 - 99 min, continuous operation
- » Impulse key: For short centrifugation operations

Safety









- » Housing and lid of metal finished in a scratch and impact resistant coating
- » Centrifuge chamber of stainless steel
- » Lid locking and holding device
- » See-through glass in the lid
- » Emergency lid lock release
- » Imbalance switch-off
- » Easily exchangeable rotors
- » Automatic rotor recognition

The C-28A conforms to safety regulations such as IEC 61010 or the EC mark and all relevant EU standards and DIN norms and has been manufactured under ISO 9001:2015

Technical details

Max. RPM (speed) / RCF: 6,000 rpm / 4,226 RCF
 Noise level: < 58 dB(A) (dependent on rotor)
 Dimensions in mm: (HxWxD) 257 x 366 x 430
 Net weight: approx. 23 kg
 Emission / Immunity: EN / IEC 61326-1 class B, FCC class B

Code	Description
BOE 01206-13	BOECO centrifuge C-28A, 208-240 V, 50/60 Hz, without rotor
BOE 01206-12	BOECO centrifuge C-28A, 100-127 V, 50/60 Hz, without rotor

capacity in ml	5	4-7	15	15	50	12	50	50
dimensions Ø x L mm	12 x 75	13 x 100	17 x 100	17 x 120	29 x 115	17 x 100	29 x 115	29 x 107
 n=4,000 min ⁻¹ Cat.-No. 01418								
	+01054A	+00716	+00716	+E2109	+E2110	+00716		
Cat.-No.	01467	01467	01467	01467	01468	01467	01468	
tubes per rotor	32	32	32	32	8	32	8	
RCF	2,182	2,612	2,540	2,594	2,486	2,540	2,486	
radius in mm	122	146	142	145	139	142	139	
run-up in sec	36							
run-down in sec. ²⁾	43							



BOECO CENTRIFUGE C-28A

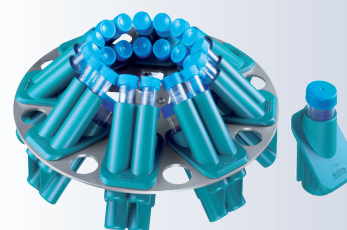

ROTOR 01418 WITH 01467

Swing-out rotor 01624, 4-place, illustrated with carriers 01369
 $n = 4,000 \text{ min}^{-1}$, max RCF 2,665, max. cap. 4 x 100 ml.

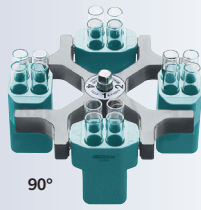

90°



Swing-out rotor, 4-place, 01624 illustrated with carriers 01481 and lids 01492 with bio-containment

capacity in ml	5	4-7	9	9	15	15	1,6 - 7	20	25	45	50
dimensions Ø x L mm	12/13x75	13x100	14x100	14x100	17x100	17x100	12/13x75 16 x 75	21x100	24x100	31x100	34x100
 $n = 4,000 \text{ min}^{-1}$ rotor Cat.-No. 01624											
Cat.-No.	01372	01739	01370	01741	01369	01742	01742	01346	01745	01345	01746
tubes per rotor	68	28	20	40	16	28	28	8	8	4	4
RCF	2,164	2,451	2,308	2,415	2,308	2,415	2,325	2,361	2,451	2,361	2,451
radius in mm	121	137	129	135	129	137	130	132	137	132	137
run-up in sec	22										
run-down in sec. ²⁾	25										

Please take care not to exceed the tubes' max. permissible RCF!

2) braked run-down

capacity in ml	1	3	5/6/7	4-10	9/15	25	30	50	50	85	100	15	50	1,6 - 7	4 - 10
dimensions Ø x L mm	6x45 rhesus	10 x 60	12 x 75-100	16x75/100	14/17 x 100	24 x 100	26 x 95	29 x 107	34 x 100	38 x 106	44 x 100	17 x 120	29 x 115	13x75/100	16x75/100
 lid with bio-containment 01492															
Cat.-No.	01339	01343	01383	01348	01329	01330	04417	04416	01331	01396	00761	01347	01384	01383	01348
tubes per rotor	108	36	20	16	16	4	4	4	4	4	4	4	4	20	16
RCF	2,594	2,630	2,558	2,522	2,540	2,433	2,451	2,630	2,415	2,612	2,558	2,665		2,558	2,522
radius in mm	145	147	143	141	142	136	137	147	135	146	143	149		143	141
run-up in sec	22														
run-down in sec. ²⁾	25														



Swing-out rotor, 4-place 01324, illustrated with carrier 01398 and adapter 01483A
 $n = 4,000 \text{ min}^{-1}$, max RCF 2,522

90°

capacity ml	5-7	9	15	2,6-3,4	4-5,5	9-10	10	4-7	15	50	12	50
dimensions Ø x L mm	12x75/82/100	14x100	17x100	13x65	15x75	16x92	15x102	16 x 75	17x120	29x115	17x100	29x115
 $n = 4,000 \text{ min}^{-1}$ rotor Cat.-No. 01324												
Cat.-No.	01486	01482A	01486	01482A	01482A	01482A	01482A	01482A	01483A	01484	01482A	01484
tubes per rotor	20	16	20	16	16	16	16	16	16	4	16	4
RCF	2,486	2,522	2,486	2,272	2,522	2,397	2,612	2,576	2,522	2,576	2,522	2,576
radius in mm	139	141	139	127	141	134	146	144	141	144		
run-up in sec	27											
run-down in sec. ²⁾	30											











Swing-out rotor, 4-place 01324, illustrated with carrier 01490 and lids 01492
 $n = 4,000 \text{ min}^{-1}$, max RCF 2,630 for max. 4 x 100 ml

capacity ml	1,5/2,0	1	3/4	5	6/7	9/15	25	50	100	10	30	50	85	15	50	12	25	30	50	
dimensions Ø x L mm	11 x 38	6 x 45 rhesus	10x60/88	12x75	12x82/100	14/17x100	24 x 100	34 x 100	44 x 100	16x80/100	26x95	29x107	38x106	17x120	29x115	17x100	25 x 90	25x110	29x115	
 lid No. 01492 biocontainment ²⁾																				
Cat.-No.	01351	01339	01343	01383	01383	01329	01330	01331	00761	01348	04417	04416	01396	01356	01347	01384	06311	01363	01365	06318
tubes per rotor	20	108	36	20	20	16	4	4	4	16	4	4	4	12	4					
RCF	2,415	2,558	2,594	2,522	2,522	2,504	2,397	2,379	2,522	2,486	2,415	2,594	2,576	2,630			2,308	2,630		
radius in mm	135	143	145	141	141	140	134	133	141	139	135	145	144	147			129	147		
run-up in sec	27																			
run-down in sec. ²⁾	30																			

90°







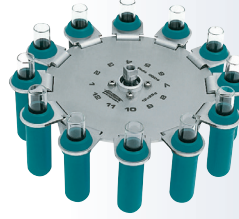

Swing-out rotor, 8-place,
for 8 x 15 ml,
n = 4,000 min⁻¹, RCF 2,415
Stainless steel, with
suspensions No. 01644, PA, fib-
reglass reinforced.

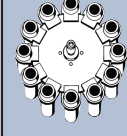
capacity in ml	5	4-7	10	15
dimensions Ø x L mm	12/13x75	17 x 70	13 x 100	17 x 100
				
n=4,000 min ⁻¹ Cat.-No. 01611				
Cat.-No.	01131-A	01132-A	01643	01644
tubes per rotor	8	8	8	8
RCF	1,914		2,415	
radius in mm	107		135	
run-up in sec.	22			
run-down in sec. ²⁾	25			







Swing-out rotor, 12-place,
for 12 x 15 ml
n = 4,000 min⁻¹, RCF 2,683,
Stainless steel, with suspensions
No. 01621, PA, fiberglass rein-
forced.

capacity in ml	5	4-7	15
dimensions Ø x L mm	12/13 x 75	15/16 x 75	17 x 100
			
n=4,000 min ⁻¹ Cat.-No. 01628			
Cat.-No.	01127-A	01122	01621
tubes per rotor	12	12	12
RCF	2,236	2,254	2,683
radius in mm	125	126	150
run-up in sec.	22		
run-down in sec. ²⁾	25		

45°







Swing-out rotor, 8-place,
for 8 x 50/15 ml Falcon tubes
n = 4,000 min⁻¹, RCF 2,469
stainless steel, with
suspensions, aluminium.

capacity in ml	15	50
dimensions Ø x L mm	17 x 120	29 x 115
		
n=4,000 min ⁻¹ Cat.-No. 01617		
Cat.-No.	01462A	—
tubes per rotor	8	
RCF	2,469	
radius in mm	138	
run-up in sec.	22	
run-down in sec. ²⁾	25	

90°

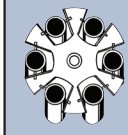

















Swing-out rotor, 6-place,
for 6 x 50/15 ml Falcon tubes
n = 4,000 min⁻¹, RCF 2,701,
Stainless steel, with suspensions,
PA, fiberglass reinforced.

capacity in ml	15	50
dimensions Ø x L mm	17 x 120	29 x 115
		
n=4,000 min ⁻¹ Cat.-No. 01619		
Cat.-No.	01462-A	—
tubes per rotor	6	
RCF	2,701	
radius in mm	151	
run-up in sec.	22	
run-down in sec. ²⁾	25	

35°



Angle rotor, 6-place,
Cat. No. 01620»
n = 6,000 min⁻¹,
max. RCF 4,226
illustrated with adapter set 01646









capacity in ml	10	15	30	50	50	85	15	50
dimensions Ø x L mm	16 x 80	17 x 100	26 x 95	29 x 107	34 x 100	38 x 106	17 x 120	29 x 115
								
n=6,000 min ⁻¹ Cat.-No. 01620A								
Cat.-No.	01448	01451	01447	01446	01463	—	01466	01646
tubes per rotor	12	6	6	6	6	6	6	6
RCF	3,904	3,904	3,824	4,025	4,146	4,226	3,985	
radius in mm	97	97	95	100	103	105	99	
run-up in sec.	19							
run-down in sec. ²⁾	22							

4) Adapter set, 6-place, for conical 50 ml tubes with screw cap

35°



Angle rotor, 12-place,
Cat. No. 01613
n = 6,000 min⁻¹,
max. RCF 4,146

capacity in ml	1,6-5	4-7	8,5-10	15	15
dimensions Ø x L mm	12/13 x 75	13 x 100	16 x 100	17 x 100	17 x 120
					
n=6,000 min ⁻¹ Cat.-No. 01613					
Cat.-No.	01054-A	01058	—	—	—
tubes per rotor	12	12	12	12	6
RCF	3,300		4,146		
radius in mm	86	103			
run-up in sec.	13				
run-down in sec. ²⁾	15				

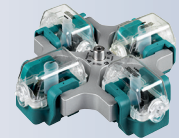

Cyto rotors, 4-place and 6-place suitable for C-28A more
information is available in a detailed cyto brochure.

2) Braked run down in sec.

Please make sure not to exceed the tubes
max. permissible RCF. For glass tubes the
max. RCF is 4,000



**BOECO MINI CENTRIFUGE
M-6**

BOECO MINI CENTRIFUGE M-6

This Mini-centrifuge is ideal for quick spin downs for Micro and PCR tubes and PCR strip. The M-6 is supplied with a 6 x 1,5/2,0ml angle rotor, a 2 x 8 x 0,2ml strip rotor and a slide rotor.

Operation of the centrifuge begins when the lid is closed. When opening the lid the rotor automatically decelerates and comes to a stop.

A rubber footplate keeps the unit stable and avoids vibration.

The M-6 is CE marked and has been manufactured under ISO 9001

Technical details

Max. RPM (speed) / RCF:	6,000 rpm / 2,000 x g
Noise level:	50 dB(A)
Power:	120 V to 240 V, 50/60 Hz
Dimensions in mm:(D/W/H)	175 x 148 x 118 mm
Net weight:	1,2 kg

Code	Description
BOE 8074000	BOECO Mini Centrifuge M-6, EU Plug
BOE 8074100	BOECO Mini Centrifuge M-6, US Plug
BOE 8074200	BOECO Mini Centrifuge M-6, UK Plug

BOECO CENTRIFUGE MICROSPIN 12

is a compact bench-top microliter centrifuge for medical and biological research, molecular diagnostics, biochemistry, immunology and cell technologies. It can be used for extracting RNA/DNA samples, separation of cell suspensions and other micro quantitative analysis.

The microprocessor control provides precise control of the set parameters and a user-friendly interface allows a easy entry of parameters.

The brushless motor provides quite, vibration free performance, even at high speeds and a long product service life.

The angle rotor is made out of aluminium.

Due to the low voltage external power supply, the Microspin 12 can be used in cold rooms.

Controls and displays

- » During centrifugation the actual values of the parameters are indicated
- » Entry of the running parameters via foil keypad
- » Speed display in RPM x 100, increment 100 rpm
- » Time t/min: 1 - 30 min, increment 1 min
- » Open lid key

Safety

- » Lid locking and holding device
- » Emergency lid lock release
- » Metal protective inserts and enclosures inside the body
- » See-through glass in the lid
- » Imbalance switch-off

The Microspin 12 conforms to safety regulations such as EN 61326, EN 61010 or the EU mark and all relevant EC standards and DIN norms and has been manufactured under ISO 9001:2015

Technical details

Max. RPM (speed) / RCF:	14,500 rpm / 12,400 x g
Noise level:	≤ 62 dB(A)
Power (external):	AC 100-240 V, 60 W/DC24 V, 2.5 A
Dimensions in mm: (D/W/H)	200 x 240 x 125 mm
Net weight:	3,4 kg

Code	Description
BOE 8075000	BOECO Micro centrifuge Microspin 12, 100-240 V, 50/60 Hz, with angle rotor for 12 x 1,5 / 2,0 ml microtubes and spin columns. And each 12 adapters for 0,2 and 0,5 ml microtubes



BOECO CENTRIFUGE MICROSPIN 12

BOECO CENTRIFUGE MC-24

Powerful, space-saving, low-noise, reliable and microprocessor-controlled microlitre centrifuge with brushless frequency drive.

Controls and displays

- » During centrifugation the actual values of the parameters are indicated
- » Entry of the running parameters via foil keypad
- » Speed display in RPM or RCF
 - RPM input from 200 to 10.000 in steps of 10, starting from 10.000 to the maximum speed in steps of 100
 - RCF input from 200 to 10.000 in steps of 1, starting from 10.000 to the maximum speed in steps of 10
- » Time t/min: 1 - 99 min. in steps of 1min.,
Time t/sec: 1-59 sec. in steps of 1 sec.,
Continuous operation
- » Brake stage, selectable between fast and slow
- » Pulse key: For short centrifugation operations
- » Open lid key

Safety

- » Lid locking and holding device
- » Emergency lid lock release
- » Motor overheating protection
- » Imbalance switch-off
- » Deep metal rotor chamber (die-cast-zinc) to securely accommodate the rotor

The MC-24 conforms to safety regulations such as IEC 61010 or the EU mark and all relevant EC standards and DIN norms and has been manufactured under ISO 9001:2015

Technical details

Max. RPM (speed) / RCF: 14,000 rpm / 18,845 RCF
 Noise level: 59 dB(A)
 Emission / Immunity: EN / IEC 61326-1 class B / FCC class B
 Dimensions in mm: (H/W/D) 228 x 262 x 352
 Net weight: 11 kg







BOECO CENTRIFUGE MC-24

Code	Description
BOE 01203-13	BOECO centrifuge MC-24, 200-240 V, 50/60 Hz, without rotor







Angle rotor,
12-place
Cat. No. 01252-A
n = 14,000 min⁻¹,
max RCF 15,558

capacity in ml	1.5	0.5/0.8	0.2 /0.4	2.0
dimensions Ø x L mm	11x38	8x30/45	6x18/45	11x38
 n = 14,000 min ⁻¹ Cat.-No. 01252-A				
	with high speeds we recommend to use adapter No. 02031			
Cat.-No.	—	02023	02024	—
tubes per rotor	12			
RCF	15,558			
radius in mm	71			
run-up in sec.	15			
run-down in sec. ²⁾	15			

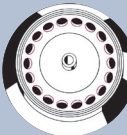

Angle rotor, 18-place,
Cat. No. 01258-A
n = 14,000 min⁻¹,
max RCF 16,654





capacity in ml	1.5	0.5/0.8	0.2 /0.4	2.0
dimensions Ø x L mm	11x38	8x30/45	6x18/45	11x38
 n = 14,000 min ⁻¹ Cat.-No. 01258-A				
	with high speeds we recommend to use adapter No. 02031			
Cat.-No.	—	02023	02024	—
tubes per rotor	18			
RCF	16,654			
radius in mm	76			
run-up in sec.	15			
run-down in sec. ²⁾	15			





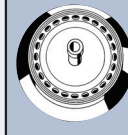



Angle rotor, 24-place,
Cat. No. 01226-A
n = 14,000 min⁻¹,
max RCF 18,845

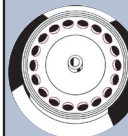

Angle rotor,
18-place,
Cat. No. 01213-A
n = 14,000 min⁻¹,
max RCF 16,654

capacity in ml	1.5	0.5/0.8	0.2 /0.4	2.0
dimensions Ø x L mm	11x38	8x30/45	6x18/45	11x38
 n = 14,000 min ⁻¹ Cat.-No. 01226-A				
	with high speeds we recommend to use adapter No. 02031			
Cat.-No.	—	02023	02024	—
tubes per rotor	24			
RCF	18,845			
radius in mm	86			
run-up in sec.	15			
run-down in sec. ²⁾	15			

capacity in ml	1.5	0.5/0.8	0.2 /0.4	2.0	1.5	2.0
dimensions Ø x L mm	11x38	8x30/45	6x18/45	11x38	micro spin columns 11x38	
 n = 14,000 min ⁻¹ Cat.-No. 01213-A						
	with high speeds we recommend to use adapter No. 02031					
Cat.-No.	—	02023	02024	—	—	—
tubes per rotor	18					
RCF	16,654					
radius in mm	76					
run-up in sec.	16					
run-down in sec. ²⁾	15					

The special raised rim of the rotor 01213-A enables centrifugation with open tube lids.



BOECO CENTRIFUGE M-240



BOECO CENTRIFUGE M-240R

BOECO CENTRIFUGES M-240 / M-240R

The M-240 and M-240R rank among the fastest centrifuges in their class – With a maximum speed of 15,000 rpm and an RCF of 21,382 they are not only fast, the M-240R also refrigerates quickly: to +4°C with the Fast Cool function in 10 to 15 minutes..

Even thermosensitive samples can be gently centrifuged thanks to highly reliable refrigeration. Best separation results are guaranteed with the smooth-running, high-performance motor featuring a maintenance-free frequency drive. With the optional autoclavable and aerosol-tight accessories, even infectious materials can be processed safely for both the user and the environment.

User-Friendliness

- » Automatic lid locking
- » Quick-entry foil keypad
- » Easy-to-read, digital display
- » Display of current parameter values
- » Select key for parameter selection
- » Impulse key for short centrifuging
- » Open lid key
- » RCF key
- » Twist knob to enter values
- » RPM in increments of 10
- » Running time in minutes, max. 99 min
- » Temperature in increments of 1°C (M-240R)
- » 4 programmable memories

Refrigeration (M-240R)

- » Infinitely variable setting from –10 °C to +40 °C
- » Fast Cool function in 10 - 15 min to +4 °C
- » Stand-by mode maintains the set temperature
- » Automatic refrigeration switch-off when the lid is opened

Safety

- » Lid dropping protection
 - » Lid locking and holding
 - » Emergency lid lock release
 - » Motor overheating protection
 - » Chamber overheating protection
 - » Imbalance switch-off
 - » Standstill indication
- with the refrigerated model M-240R the LED in the Open key lights up with the M-240 the lid opens automatically after the rotor has come to a standstill

The M-240 / M-240R conform to safety regulations such as IEC 61010, all relevant EU standards and DIN norms and have been manufactured under ISO 9001:2015

Technical details

	M-240	M-240R
Max. RPM (speed) / RCF:	15,000 RPM / 21,382 RCF	
Noise level: (dependent on rotor)	≤ 58 dB (A)	≤ 54 dB(A)
Dimensions in mm (HxWxD):	260 x 275 x 344	260 x 281 x 533
Net weight:	11,5 kg	28 kg
Emission / Immunity:	EN / IEC 61326-1 / class B / FCC class B	





Code	Description
BOE 02400-13	BOECO centrifuge M-240, 200-240 V, 50/60 Hz, without rotor
BOE 02405-13	BOECO refrigerated centrifuge M-240R, 200-240 V, 50 Hz, without rotor

Rotors for M-240 and M-240 R

45°









Angle rotor, 24-place
Cat. No. 02434
 n= 15,000 min⁻¹,
 max RCF 21,382
 incl. biocontainment lid

capacity in ml	1.5	0.5/0.8	0,2 /0.4	2.0
dimensions Ø x L mm	11x38	8x30/45	6x18/45	11x38
 n=15,000 min ⁻¹ Cat.-No. 02434				
	with high speeds we recommend to use adapter No. 02031			
Cat.-No.	—	02023	02024	—
tubes per rotor	24			
RCF	21,382			
radius in mm	85			
run-up in sec.	20			
run-down in sec. ²⁾	29			
temperature °C ³⁾	+4			

45°



Angle rotor, 24-place
Cat. No. 02428
 n= 15,000 min⁻¹,
 max RCF 21,382
 incl. bioseal lid





capacity in ml	1.5	0.5/0.8	0,2 /0.4	2.0	1.5	2.0
dimensions Ø x L mm	11x38	8x30/45	6x18/45	11x38	micro spin columns 11x38	
 n=15,000 min ⁻¹ Cat.-No. 02428						
	with high speeds we recommend to use adapter No. 02031				with high speeds we recommend to use adapter No. 02031	
Cat.-No.	—	02023	02024	—	—	—
tubes per rotor	24					
RCF	21,382					
radius in mm	85					
run-up in sec.	20					
run-down in sec. ²⁾	28					
temperature °C ³⁾	+4					

The special raised rim of the rotor 02428 enables centrifugation of tubes with open lids. The rim supports the lids so they will not rip off during centrifugation. Centrifugation with open tube lids is performed for example when spinning tubes with filter elements, so called „spin columns“

40° inside /
52,5° outside



Angle rotor, 30-place,
Cat. No. 02437
 n= 15,000 min⁻¹,
 max RCF 21,328
 incl. bioseal lid.

capacity in ml	1.5	0.5/0.8	0,2 /0.4	2.0
dimensions Ø x L mm	11x38	8x30/45	6x18/45	11x38
 n=15,000 min ⁻¹ Cat.-No. 02437				
	with high speeds we recommend to use adapter No. 02031			
Cat.-No.	—	02023	02024	—
tubes per rotor	30			
RCF	21,328			
radius in mm	85			
run-up in sec.	22			
run-down in sec. ²⁾	30			
temperature °C ³⁾	+4			

Optional for rotor 02437 and 02434



Lid (Cat. No. 02435)
 with bio-containment
 autoclavable,
 phenol-resistant



BOECO CENTRIFUGE U-320



BOECO CENTRIFUGE U-320R

BOECO CENTRIFUGES U-320 / U-320R

Because of their comprehensive range of accessories, the U-320 and U-320R centrifuges are the perfect universal centrifuges for routines in basic research and R&D laboratories of the pharmaceutical and biotechnical industry. The microprocessor controlled centrifuges have a brushless frequency drive (no carbon brushes) and a motorized lid locking.

Performance

- » High RCF
- » Extremely short run-up and run-down times

Design

- » Metal housing, metal lid
- » Stainless steel centrifugation chamber
- » Viewing port in the lid

Refrigeration (U-320R)

- » Infinitely variable setting from $-20\text{ }^{\circ}\text{C}$ to $+40\text{ }^{\circ}\text{C}$
- » Fast cool function

User-Friendliness

- » Automatic lid locking
- » Easily exchangeable rotors
- » 10 programmable memories
- » 9 acceleration and braking ramps, or unbroken run down time

Safety

- » Lid locking and holding during rotor run
- » Emergency lid lock release
- » Motor overheating protection
- » Chamber overheating protection (with U-320R)
- » Imbalance switch-off
- » Automatic rotor recognition
- » Lid dropping protection

Controls and displays

- » During centrifugation the actual values of the parameters are indicated
- » Change-over RPM/RCF: by entering the rotor radius r/mm the Centrifuge will calculate/indicate speed or RCF.
- » Time preselection in steps of minutes and seconds / continuous operation
- » Temperature $T/^{\circ}\text{C}$: Input in increments of 1°C
- » Impulse key: For short centrifugation operations

The U-320 / U-320R conform to safety regulations such as IEC 61010 or the EC mark and all relevant EU standards and DIN norms and have been manufactured under ISO 9001:2015

Technical details























	U-320	U-320 R
Max. Capacity:	4 x 200 ml, 6 x 94 ml	
Max. RPM (speed) / RCF:	15,000 RPM / 21,382 RCF	
Noise level:	$\leq 68\text{ dB (A)}$	$\leq 58\text{ dB(A)}$
(dependent on rotor)		
Dimensions in mm (HxWxD):	346 x 395 x 520	346 x 401 x 695
Net weight:	31 kg	52 kg
Emission / Immunity:	EN IEC 61326-1, class B / FCC Class B	

Code	Description
BOE 01401-13	BOECO centrifuge U-320, 200-240 V, 50/60 Hz, without rotor
BOE 01406-13	BOECO refrigerated centrifuge U-320R, 200-240 V, 50 Hz, 240 V, 60 Hz, without rotor

Swing-out rotor 01624, 4-place,
illustrated with
carriers 01369
n= 4,000 min⁻¹,
max. RCF 2,665
max. cap. 4 x 100 ml.















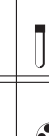

Swing-out rotor,
No. 01624, 4-place,
n= 4,000 min⁻¹,
max. RCF 2,665
for max. 4 x 100 ml

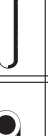
capacity in ml	5	4-7	9	9	15	1,6-7	15	20	25	45	50
dimensions Ø x L mm	12/13x75	13 x 100	14 x 100	14 x 100	17 x 100	12/13x75 16 x 75	17 x 100	21 x 100	24 x 100	31 x 100	34 x 100
											
n=4,000 min ⁻¹ Cat.-No. 01624											
Cat.-No.	01372	01739	01370	01741	01369	01742	01742	01346	01745	01345	01746
tubes per rotor	68	28	20	40	16	28	28	8	8	4	4
RCF	2,164	2,451	2,308	2,415	2,308	2,325	2,415	2,361	2,451	2,361	2,451
radius in mm	121	137	129	135	129	130	137	132	137	132	137
run-up in sec	20	22		20		22		20			
run-down in sec. ²⁾						25					
temperature °C ¹⁾		- 17		- 15	- 17	- 15	- 15	- 15	- 15	- 17	- 15

1) Lowest attainable temperature in the U-320 R at max. speed.



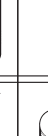











2) braked run-down

Please take care not to exceed the tubes' max. permissible RCF!

capacity in ml	1	3	1,6-7	4-10	9/15	25	30	50	50	85	100	15	50	1,6-7	4-10
dimensions Ø x L mm	6x45 Rhesus	10 x 60	13 x 75/100	16x75/100	14/17 x 100	24 x 100	26 x 95	29 x 107	34 x 100	38 x 106	44 x 100	17 x 120	29 x 115	13x75/100	16x75/100
															
Cat.-No.	01339	01343	01383	01348	01329	01330	04417	04416	01331	01396	00761	01347	01384	01383	01348
tubes per rotor	108	36	20	16	16	4	4	4	4	4	4	4	4	20	16
RCF	2,594	2,630	2,558	2,522	2,540	2,433	2,451	2,630	2,415	2,612	2,558	2,665	2,665	2,558	2,522
radius in mm	145	147	143	141	142	136	137	147	135	146	143	149	149	143	141
run-up in sec															
run-down in sec. ²⁾															
temperature °C ¹⁾															











Swing-out rotor, No. 01494
4-place,
n= 5,000 min⁻¹,
max. RCF 4,193
illustrated with buckets
01427

capacity ml	1.5/2.0	1	3	5	6	7	9	15	25	50	15	25	30	50
dimensions Ø x L mm	11 x 38	6 x 45 Rhesus	10 x 60	13 x 75	12 x 82	12 x 100	14 x 100	17 x 100	24 x 100	34 x 100	17 x 120	25 x 90	25 x 110	29 x 115
														
Cat.-No.	05277	01357	01327	01732	05229	05230	05237	05231	05232	05233	05275	01731	05272	05276
tubes per rotor	36	120	48	32	48	48	24	24	8	4	4	8	4	4
RCF	4,109	4,081	4,053	4,025	4,053			3,941			4,165	3,969	4,025	4,053
radius in mm	147	146	145	144	145			141			149	142	144	145
run-up in sec								30						
run-down in sec. ²⁾								32						
temperature °C ¹⁾								- 7						

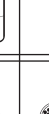
3) When using these tubes, bucket 01427 cannot be closed with lid 01421

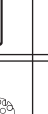
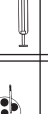
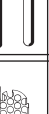

Swing-out rotor, No. 01494
4-place,
n= 5,000 min⁻¹,
max. RCF 4,193
illustrated with buckets 01425

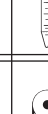
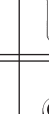
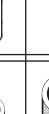
capacity ml	1.5/2.0	1	3	2,6-7	5/6/7	9/15	25	50	100	15	50	50	4-10
dimensions Ø x L mm	11 x 38	6 x 45 Rhesus	10 x 60	11x100	12x75-100	14/17x100	24 x 100	34 x 100	44 x 100	17 x 120	29 x 115	29 x 115	16 x 75/100
													
Cat.-No.	01444	01432	01433	01438	01434	01431	01435	01436	01437	01442	01443	01737	01441
tubes per rotor	36	144	56	28	48	28	8	4	4		4		28
RCF		3,969			3,913				3,801		4,081		3,913
radius in mm	139	142			140				136		146		140
run-up in sec								30					
run-down in sec. ²⁾								32					
temperature °C ¹⁾								- 10					

capacity ml	1.5/2.0	1	3	5	6/7	9/15	25	50	100	10	30	50	85	15	50	12	25	30	50	
dimensions Ø x L mm	11 x 38	6 x 45 Rheus	10x60	13x75	13x82/100	14/17x100	24 x 100	34 x 100	44 x 100	16x80/100	26x95	29x107	38x106	17x120	29x115	17x100	25 x 90	25x110	29x115	
lid No. 01492 biocontainment ⁵⁾																				
Carrier Cat.-No. 01495																				
Cat.-No.	01351	01339	01343	01383	01383	01329	01330	01331	00761	01348	04417	04416	01396	01347	01384	06311	01363	01365	06318	
tubes per rotor	20	108	36	20	20	16	4	4	4	16	4	4	4				4			
RCF	3,857	4,081	4,137	4,025	4,025	3,997	3,829	3,801	4,025	4,025	3,857	4,137	4,109		4,193		3,689		4,193	
radius in mm	138	146	148	144	144	143	137	136	144	144	138	148	147		150		132		150	
run-up in sec											30									
run-down in sec. ²⁾											32									
temperature °C ³⁾											- 10									



Swing-out rotor 01324, 4-place,
illustrated with suspension 01398
and adapter 01483
n= 4,500 min⁻¹,
max. RCF 3,260



Swing-out rotor 01324, 4-place,
illustrated with
carrier 01490 and lids 01492
n= 4,500 min⁻¹,
max. RCF 3,328
for max. 4 x 100 ml

capacity ml	9	15	2,6-3,4	4-5,5	9-10	10	4-7	15	50	12	50	
dimensions Ø x L mm	14x100	17x100	13x65	15x75	16x92	15x102	16 x 75	17x120	29x115	17x100	29x115	
Carrier Cat.-No. 01398												
Cat.-No.	01482-A	01486	01482-A	01482-A	01482-A	01483-A	01484	01482-A	01484	01482-A	01484	
tubes per rotor	16	20	16	16	16	16	16	16	4	16	4	
RCF	3,192	3,147	2,875	3,192	3,034	3,305	3,260	3,192	3,260	3,192	3,260	
radius in mm	141	139	127	141	134	146	144	141	144			
run-up in sec							27					
run-down in sec. ²⁾							30					
temperature °C ³⁾							- 6					

capacity ml	1.5/2.0	1	3/4	5	6/7	9/15	25	50	100	4-10	30	50	85	15	50	12	25	30	50	
dimensions Ø x L mm	11 x 38	6 x 45 Rheus	10x60/88	12/13x75	13x82/100	14/17x100	24 x 100	34 x 100	44 x 100	16x75/100	26x95	29x107	38x106	17x120	29x115	17x100	25 x 90	25x110	29x115	
lid No. 01492 biocontainment ⁵⁾																				
Carrier Cat.-No. 01490																				
Cat.-No.	01351	01339	01343	01383	01383	01329	01330	01331	00761	01348	04417	04416	01396	01356	01347	01384	06311	01363	01365	06318
tubes per rotor	20	108	36	20	20	16	4	4	4	16	4	4	4	12			4			
RCF	3,056	3,237	3,283	3,192	3,192	3,170	3,034	3,011	3,192	3,147	3,056	3,283	3,260		3,328		2,920		3,328	
radius in mm	135	143	145	141	141	140	134	133	141	139	135	145	144		147		129		147	
run-up in sec											27									
run-down in sec. ²⁾											30									
temperature °C ³⁾											- 6									



Swing-out rotor, 8-place,
n= 4,000 min⁻¹,
max. RCF 2,415,
for 8 x 15 ml,
stainless steel,
with suspensions No. 01644, PA,
fibreglass reinforced.

capacity in ml	5	10	10	15
dimensions Ø x L mm	12/13x75	17 x 70	13 x 100	17 x 100
Carrier Cat.-No. 01611				
Cat.-No.	01131-A	01132-A	01643	01644
tubes per rotor	8	8	8	8
RCF	1,914		2,415	
radius in mm	107		135	
run-up in sec	20			
run-down in sec. ²⁾	20			
temperature °C ³⁾	-16			



Swing-out rotor, 12-place,
n= 5,000 min⁻¹,
max. RCF 4,193,
for 12 x 15 ml, stainless steel,
with suspensions No. 01621, PA,
fibreglass reinforced.

capacity in ml	5	10	15
dimensions Ø x L mm	12/13 x 75	17 x 70	17 x 100
Carrier Cat.-No. 01628			
Cat.-No.	01127-A	01122	01621
tubes per rotor	12	12	12
RCF	3,494	3,522	4,193
radius in mm	125	126	150
run-up in sec	16		
run-down in sec. ²⁾	16		
temperature °C ³⁾	-15	-10	

capacity ml	1.5/2.0	5	5-7	1,6-7	9/15	25	50	85	100	125/150	200	30	50	15	50	12	25/30	50	
dimensions Ø x L mm	11 x 38	17x59	12x75/100	13x75/100	14/17x100	24 x 100	34 x 100	38x101/6	44 x 100	51x100/116	56 x 112	26 x 95	29 x 107	17 x 120	29 x 115	17 x 100	25x90/110	29x115	
lid No. 01561 biocontainment ⁵⁾																			
Carrier Cat.-No 01560																			
Cat.-No.	01571	01593	01589	01589	01588	01573	01574	01575	01576	01594	-	01585	01586	01577	01595	01579	01582	01582	01583
tubes per rotor	56	16	28	28	20	4	4	4	4	4	4	4	4	8	12	4	16	16	4
max. RCF	3,328/ 3,332	3,328	3,215	3,215	3,215	3,056	3,147	3,260	3,147	3,328	3,328	3,260	3,260	3,328	3,328	3,260	3,260	3,328	
radius in mm	147/103	147	142	142	142	135	139	144	139	147	147	144	144	147	147	144	144	147	
run-up in sec	28																		
run-down in sec. ²⁾	31																		
temperature °C ¹⁾	- 8																		

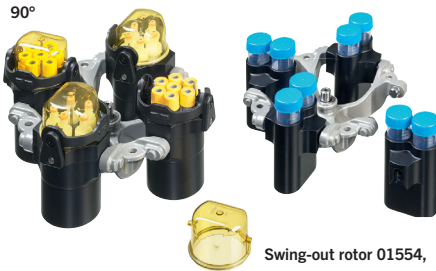

Swing-out rotor, 01554, 4-place, illustrated with carrier 01560 and lids 01561
n= 4,500 min⁻¹, max. RCF 3,328 for max. 4 x 200 ml

Swing-out rotor 01554, 4-place, illustrated with carrier 01563

capacity in ml	12	15	50	50
dimensions Ø x L mm	17 x 100	17 x 120	29 x 115	29 x 115
Carrier Cat.-No. 01563				
Cat.-No.	01592	01592	-	-
tubes per rotor	8			
RCF	3,260			
radius in mm	144			
run-up in sec	28			
run-down in sec. ²⁾	31			
temperature °C ¹⁾	-8			



Swing-out rotor, 6-place, n= 4,000 min⁻¹, RCF 2,701, for 6 x 50/15ml Falcon tubes, stainless steel, with suspensions, PA, fiberglass reinforced.

capacity in ml	15	50
dimensions Ø x L mm	17 x 120	29 x 115
n=4,000 min ⁻¹ Cat.-No 01619		
Cat.-No.	01462-A	-
tubes per rotor	6	
RCF	2,701	
radius in mm	151	
run-up in sec	20	
run-down in sec. ²⁾	22	
temperature °C ¹⁾	- 15	



Swing-out rotor, 8-place, n= 5,000 min⁻¹, RCF 3,857, for 8 x 50/15 ml, stainless steel, with suspensions, aluminium.

capacity in ml	15	50
dimensions Ø x L mm	17 x 120	29 x 115
n=5,000 min ⁻¹ Cat.-No. 01617		
Cat.-No.	01462-A	-
tubes per rotor	8	
RCF	3,857	
radius in mm	138	
run-up in sec	20	
run-down in sec. ²⁾	19	
temperature °C ¹⁾	- 10	



Swing-out rotor, 24-place, with bioseal, phenol-resistant lid n= 13,000 min⁻¹, RCF 18,127

capacity in ml	1.5	0.5/0.8	0.2/0.4	2.0
dimensions Ø x L mm	11x38	8x30/45	6x18/45	11x38
incl. biosal lid n=13,000 min ⁻¹ Cat.-No. 01555				
Cat.-No.	-	02023	02024	-
tubes per rotor	24			
RCF	18,327			
radius in mm	97			
run-up in sec	36			
run-down in sec. ²⁾	31			
temperature °C ¹⁾	3			



Swing-out rotor, 2-place, n=4,000 min⁻¹, RCF 2,218 for microtitre plates, aluminium, coated, with suspensions No. 01453-A, stainless steel.

	microtitre plate	culture plate	deep well plate	MS	QP	Microtest plate (Terasaki)	PCR plate 96 wells	PCR strips 0,2
n=4,000 min ⁻¹ Rotor Cat.-No. 01460								
Cat.-No.	01453-A						01453-A + 01485	
plates per rotor	10	8	6	2	2	4	2	24 x 8
RCF	2,218							
radius in mm	124							
run-up in sec	40							
run-down in sec. ²⁾	45							
temperature °C ¹⁾	-6							







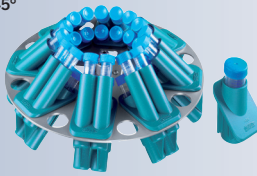







- 1) Lowest attainable temp. in precooled refrigerated centrifuges at max. speed.
- 2) Rnd down in sec. braked

Please make sure not to exceed the tubes max. permissible RCF. For glass tubes the max. RCF is 4,000

45°





Angle rotor,
Cat. No. 01418
8-place
N = 4.500 min⁻¹
max. RCF 3,305
illustrated with adapters 01467

capacity in ml	4-7	15	15	50	12	50	50
dimensions Ø x L mm	13 x 100	17 x 100	17 x 120	29 x 115	17 x 100	29 x 115	29 x 107
 n=4,500 min ⁻¹ Cat.-No. 01418							
							
Cat.-No.	01467	01467	01467	01468	01467	01468	
tubes per rotor	32	32	32	8	32	8	
RCF	3,305	3,215	3,283	3,147	3,215	3,147	
radius in mm	146	142	145	139	142	139	
run-up in sec	30						
run-down in sec. ²⁾	31						
temperature °C ¹⁾	-11						

45°



















Angle rotor,
Cat. No. 01627
18-place, with bioseal, phenol-resistant lid
n= 14,150 min⁻¹,
RCF 22.161,
for 5 ml microtest tubes

capacity in ml	5,0 ml
dimensions Ø x L mm	17 x 59
 n=14,500 min ⁻¹ Cat.-No. 01627	
	
Cat.-No.	
tubes per rotor	18
RCF	22,161
radius in mm	
run-up in sec	35
run-down in sec. ²⁾	32
temperature °C ¹⁾	2

35°



Angle rotor,
Cat. No. 01556
6-place,
n= 9,000 min⁻¹,
max. RCF 10,595

capacity in ml	10	10-15	30	50	50/75	85	15	50
dimensions Ø x L mm	16 x 80	17 x 100	26 x 95	29 x 107	34 x 100 35 x 105	38 x 106	17 x 120	29 x 115
 n=9,000 min ⁻¹ Cat.-No. 01556								
								
Cat.-No.	01477	01478	01447	01446	01463	—	01466	01454
tubes per rotor	12	6	6	6	6	6	6	6
RCF	10.414	10.052	9.690	10,142	10,414	10.595	10.052	
radius in mm	115	111	107	112	115	117	111	
run-up in sec	30							
run-down in sec. ²⁾	30							
temperature °C ¹⁾	- 11							

1) Lowest attainable temp. in precooled refrigerated centrifuges at max. speed



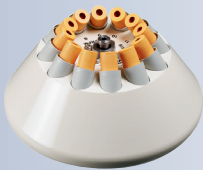

2) Rund down in sec. braked

Please make sure not to exceed the tubes max. permissible RCF. for glass tubes the max. RCF is 4,000

35°









Angle rotor,
Cat. No. 01613
12-place,
n= 6,000 min⁻¹,
max. RCF 4,146

capacity in ml	5	15	15
dimensions Ø x L mm	12/13 x 75	17 x 100	17 x 120
 n=6,000 min ⁻¹ Cat.-No. 01613			
			
Cat.-No.	01054A	—	—
tubes per rotor	12	12	6
RCF	3,300	4,146	
radius in mm	82	103	
run-up in sec	15		
run-down in sec. ²⁾	15		
temperature °C ¹⁾	- 16		

35°









Angle rotor,
Cat. No. 01615
12-place,
n= 12,000 min⁻¹, max.
RCF 16,582

capacity in ml	5	15	15
dimensions Ø x L mm	12/13x75	17 x 100	17 x 120
 n=12.000 min ⁻¹ Cat.-No. 01615			
			
Cat.-No.	01054A	—	01647
tubes per rotor	12	12	6
RCF	13,201	16,582	15,455
radius in mm	82	103	93
run-up in sec	40		
run-down in sec. ²⁾	40		
temperature °C ¹⁾	-2		

50°











Angle rotor,
Cat. No. 01552
24-place,
incl. bioseal lid,
phenol resistant
n= 16,000 min⁻¹, max.
RCF 24,900

capacity in ml	1.5	0.5/0.8	0.2/0.4	2.0
dimensions Ø x L mm	11x38	8x30/45	6x18/45	11x38
 incl. bioseal lid n=16,000 min ⁻¹ Cat.-No. 01552				
				
Cat.-No.	—	02023	02024	—
tubes per rotor	24			
RCF	24,900			
radius in mm	87			
run-up in sec	30			
run-down in sec. ²⁾	29			
temperature °C ¹⁾	2			

45°



Angle rotor,
Cat. No. 01553
30-place,
incl. bioseal lid, phenol resistant
n= 14,150 min⁻¹
max RCF 21,713

capacity in ml	1.5	0.5/0.8	0.2/0.4	2.0
dimensions Ø x L mm	11x38	8x30/45	6x18/45	11x38
 incl. bioseal lid n=14,150 min ⁻¹ Cat.-No. 01553				
				
Cat.-No.	—	02023	02024	—
tubes per rotor	30			
RCF	21,713			
radius in mm	97			
run-up in sec	35			
run-down in sec. ²⁾	32			
temperature °C ¹⁾	-1			

Cyto rotors, suitable for U-320 and U-320R are available.
More informations are available in a detailed cyto brochure.

